





Grayhill, Inc.

62S11-N4-PH

Part Number:	62S11-N4-PH
Producent / marka:	Grayhill, Inc.
Opis produktu	ROTARY ENCODER OPTICAL 32PPR
Arkusze danych:	 62S11-N4-PH.pdf
Status RoHS	 Bezołowiowe / Zgodny z RoHS
Stan magazynowy	1970 pcs stock
Statek z	Hongkong
Sposób wysyłki	DHL/Fedex/TNT/UPS/EMS

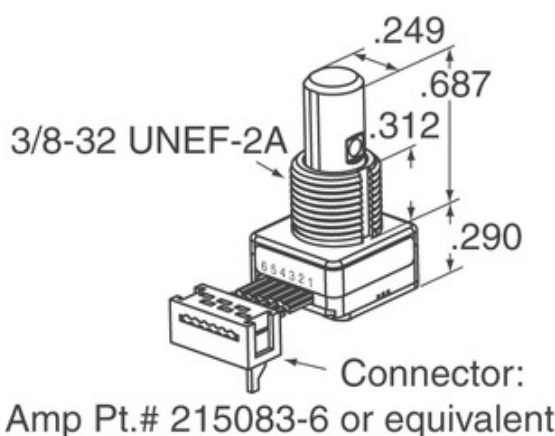
[PROŚBA O OFERTĘ](#)

Obraz może być reprezentacją. Zobacz specyfikację dla szczegółów produktu.







Specyfikacje 62S11-N4-PH

PART NUMBER	62S11-N4-PH
PRODUCENT	Grayhill, Inc.
OPIS	ROTARY ENCODER OPTICAL 32PPR
STAN OŁOWIU / STATUS ROHS	Bezołowiowe / Zgodny z RoHS
DOSTĘPNA ILOŚĆ	1970 pcs
ARKUSZ DANYCH	 62S11-N4-PH.pdf
NAPIĘCIE - DOSTAWA	5V
TERMINATION STYLE	PC Pin
SERIA	62S
CYKLE OBROTOWA NATURA (MIN)	1M
IMPULSÓW NA OBRÓT	32
TYP WYJŚCIA	Quadrature (Incremental)
INNE NAZWY	62S11N4PH
ORIENTACJA	Vertical
RODZAJ MOCOWANIA	PCB, Through Hole
POZIOM CZUŁOŚCI NA WILGOĆ (MSL)	1 (Unlimited)
STATUS BEZOŁOWIOWY / STATUS ROHS	Lead free / RoHS Compliant
ENCODER TYPE	Optical
SAMOBLOKUJĄCY	No
WBUDOWANY WYŁĄCZNIK	Yes
TYP URZĄDZENIA URUCHAMIAJĄCEGO	1/4" Dia Flatted End

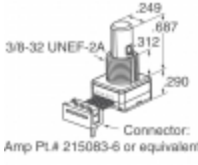
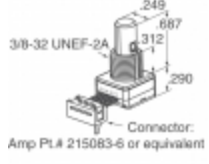
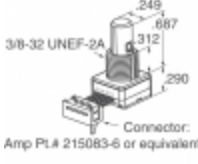
Powiązane tagi

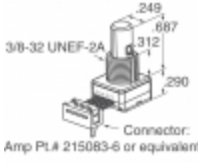
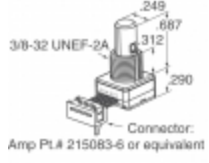
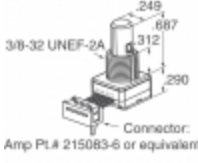
Grayhill, Inc. 62S11-N4-PH	Dystrybutor 62S11-N4-PH	Dostawca 62S11-N4-PH
62S11-N4-PH Cena	Zdjęcia 62S11-N4-PH	Obraz 62S11-N4-PH
Arkusz danych PDF 62S11-N4-PH	62S11-N4-PH Pobierz arkusz danych	Arkusz danych 62S11-N4-PH
62S11-N4-PH Akcje	Kup 62S11-N4-PH	Kup Grayhill, Inc. 62S11-N4-PH
Grayhill, Inc. 62S11-N4-PH	Dostawca Grayhill, Inc.	Dystrybutor Grayhill, Inc.
Grayhill, Inc. 62S11-N4-PH	Grayhill Inc. 62S11-N4-PH	

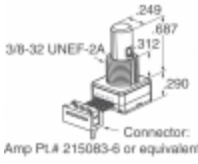
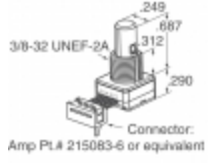
Produkty powiązane

 <p>62S11-N4-025C Producenci: Grayhill, Inc. Opis: ROTARY ENCODER OPTICAL 32PPR Na stanie: 1970 pcs</p> <p>RFQ</p>	 <p>62S11-N4-120S Producenci: Grayhill, Inc. Opis: ROTARY ENCODER OPTICAL 32PPR Na stanie: 2038 pcs</p> <p>RFQ</p>
 <p>62S11-N4-025CH Producenci: Grayhill, Inc. Opis: ROTARY ENCODER OPTICAL 32PPR Na stanie: 1946 pcs</p> <p>RFQ</p>	 <p>62S11-N5-060SH Producenci: Grayhill, Inc. Opis: ROTARY ENCODER OPTICAL 32PPR Na stanie: 2263 pcs</p> <p>RFQ</p>
 <p>62S11-N4-020C Producenci: Grayhill, Inc. Opis: ROTARY ENCODER OPTICAL 32PPR Na stanie: 2083 pcs</p> <p>RFQ</p>	 <p>62S11-N5-060C Producenci: Grayhill, Inc. Opis: ROTARY ENCODER OPTICAL 32PPR Na stanie: 2164 pcs</p> <p>RFQ</p>
 <p>62S11-N4-P Producenci: Grayhill, Inc. Opis: ROTARY ENCODER OPTICAL 32PPR Na stanie: 1912 pcs</p> <p>RFQ</p>	 <p>62S11-N5-050C Producenci: Grayhill, Inc. Opis: ROTARY ENCODER OPTICAL 32PPR Na stanie: 1936 pcs</p> <p>RFQ</p>
 <p>62S11-N5-025CH Producenci: Grayhill, Inc. Opis: ROTARY ENCODER OPTICAL 32PPR Na stanie: 2083 pcs</p> <p>RFQ</p>	 <p>62S11-N5-040C Producenci: Grayhill, Inc. Opis: ROTARY ENCODER OPTICAL 32PPR Na stanie: 2106 pcs</p> <p>RFQ</p>
 <p>62S11-N4-060SH Producenci: Grayhill, Inc. Opis: ROTARY ENCODER OPTICAL 32PPR Na stanie: 2262 pcs</p> <p>RFQ</p>	 <p>62S11-N5-025C Producenci: Grayhill, Inc. Opis: ROTARY ENCODER OPTICAL 32PPR Na stanie: 2408 pcs</p> <p>RFQ</p>

Copyright © 2020 Niezawodny dystrybutor komponentów elektronicznych

E-mail: Info@infinity-electronic.com

Adres: 17F, budynek handlowy Gaylord, 114-118 Lockhart Road, Wan Chai, Hongkong

