





Grayhill, Inc.

## 62S11-N4-P

Part Number:	62S11-N4-P
Producent / marka:	Grayhill, Inc.
Opis produktu	ROTARY ENCODER OPTICAL 32PPR
Arkusze danych:	 62S11-N4-P.pdf
Status RoHS	 Bezołowiowe / Zgodny z RoHS
Stan magazynowy	1912 pcs stock
Statek z	Hongkong
Sposób wysyłki	DHL/Fedex/TNT/UPS/EMS

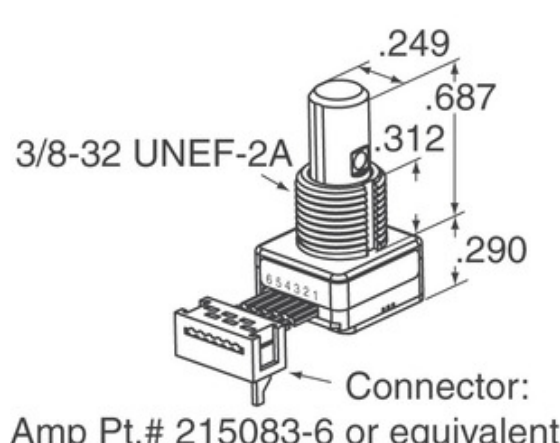
[PROŚBA O OFERTĘ](#)

Obraz może być reprezentacją. Zobacz specyfikację dla szczegółów produktu.





### Specyfikacje 62S11-N4-P

PART NUMBER	62S11-N4-P
PRODUCENT	Grayhill, Inc.
OPIS	ROTARY ENCODER OPTICAL 32PPR
STAN OŁOWIU / STATUS ROHS	Bezołowiowe / Zgodny z RoHS
DOSTĘPNA ILOŚĆ	1912 pcs
ARKUSZ DANYCH	 62S11-N4-P.pdf
NAPIĘCIE - DOSTAWA	5V
TERMINATION STYLE	PC Pin
SERIA	62S
CYKLE OBROTOWA NATURA (MIN)	1M
IMPULSÓW NA OBRÓT	32
TYP WYJŚCIA	Quadrature (Incremental)
INNE NAZWY	62S11N4P
ORIENTACJA	Vertical
RODZAJ MOCOWANIA	PCB, Through Hole
POZIOM CZUŁOŚCI NA WILGOĆ (MSL)	1 (Unlimited)
STATUS BEZOŁOWIOWY / STATUS ROHS	Lead free / RoHS Compliant
ENCODER TYPE	Optical
SAMOBLOKUJĄCY	No
WBUDOWANY WYŁĄCZNIK	Yes
TYP URZĄDZENIA URUCHAMIAJĄCEGO	1/4" Dia Flatted End

### Powiązane tagi

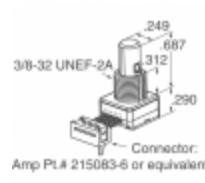
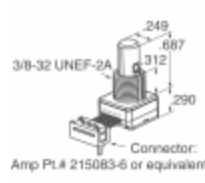
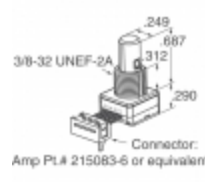
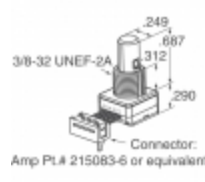
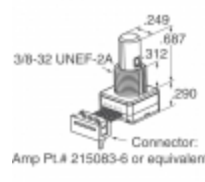
Grayhill, Inc. 62S11-N4-P	Dystrybutor 62S11-N4-P	Dostawca 62S11-N4-P
62S11-N4-P Cena	Zdjęcia 62S11-N4-P	Obraz 62S11-N4-P
Arkusz danych PDF 62S11-N4-P	62S11-N4-P Pobierz arkusz danych	Arkusz danych 62S11-N4-P
62S11-N4-P Akcje	Kup 62S11-N4-P	Kup Grayhill, Inc. 62S11-N4-P
Grayhill, Inc. 62S11-N4-P	Dostawca Grayhill, Inc.	Dystrybutor Grayhill, Inc.
Grayhill, Inc. 62S11-N4-P	Grayhill Inc. 62S11-N4-P	

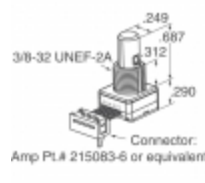
### Produkty powiązane

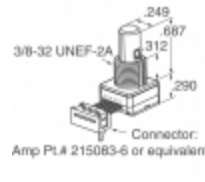
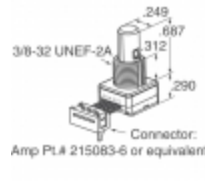
 <p><b>62S11-N4-025CH</b>          Producenci: Grayhill, Inc.          Opis: ROTARY ENCODER OPTICAL 32PPR          Na stanie: 1946 pcs</p> <p><a href="#">RFQ</a></p>	 <p><b>62S11-N3-PH</b>          Producenci: Grayhill, Inc.          Opis: ROTARY ENCODER OPTICAL 32PPR          Na stanie: 1856 pcs</p> <p><a href="#">RFQ</a></p>
 <p><b>62S11-N4-060SH</b>          Producenci: Grayhill, Inc.          Opis: ROTARY ENCODER OPTICAL 32PPR          Na stanie: 2262 pcs</p> <p><a href="#">RFQ</a></p>	 <p><b>62S11-N4-120S</b>          Producenci: Grayhill, Inc.          Opis: ROTARY ENCODER OPTICAL 32PPR          Na stanie: 2038 pcs</p> <p><a href="#">RFQ</a></p>
 <p><b>62S11-N5-050C</b>          Producenci: Grayhill, Inc.          Opis: ROTARY ENCODER OPTICAL 32PPR          Na stanie: 1936 pcs</p> <p><a href="#">RFQ</a></p>	 <p><b>62S11-N4-020C</b>          Producenci: Grayhill, Inc.          Opis: ROTARY ENCODER OPTICAL 32PPR          Na stanie: 2083 pcs</p> <p><a href="#">RFQ</a></p>
 <p><b>62S11-N5-025C</b>          Producenci: Grayhill, Inc.          Opis: ROTARY ENCODER OPTICAL 32PPR          Na stanie: 2408 pcs</p> <p><a href="#">RFQ</a></p>	 <p><b>62S11-N5-040C</b>          Producenci: Grayhill, Inc.          Opis: ROTARY ENCODER OPTICAL 32PPR          Na stanie: 2106 pcs</p> <p><a href="#">RFQ</a></p>
 <p><b>62S11-N4-025C</b>          Producenci: Grayhill, Inc.          Opis: ROTARY ENCODER OPTICAL 32PPR          Na stanie: 1970 pcs</p> <p><a href="#">RFQ</a></p>	 <p><b>62S11-N5-025CH</b>          Producenci: Grayhill, Inc.          Opis: ROTARY ENCODER OPTICAL 32PPR          Na stanie: 2083 pcs</p> <p><a href="#">RFQ</a></p>
 <p><b>62S11-N4-PH</b>          Producenci: Grayhill, Inc.          Opis: ROTARY ENCODER OPTICAL 32PPR          Na stanie: 1970 pcs</p> <p><a href="#">RFQ</a></p>	 <p><b>62S11-N5-060C</b>          Producenci: Grayhill, Inc.          Opis: ROTARY ENCODER OPTICAL 32PPR          Na stanie: 2164 pcs</p> <p><a href="#">RFQ</a></p>

Copyright © 2020 Niezawodny dystrybutor komponentów elektronicznych

E-mail: [Info@infinity-electronic.com](mailto:Info@infinity-electronic.com)

Adres: 17F, budynek handlowy Gaylord, 114-118 Lockhart Road, Wan Chai, Hongkong

