





Grayhill, Inc.

62S11-N4-060SH

Part Number:	62S11-N4-060SH
Producent / marka:	Grayhill, Inc.
Opis produktu	ROTARY ENCODER OPTICAL 32PPR
Arkusze danych:	 62S11-N4-060SH.pdf
Status RoHS	 Bezołowiowe / Zgodny z RoHS
Stan magazynowy	2262 pcs stock
Statek z	Hongkong
Sposób wysyłki	DHL/Fedex/TNT/UPS/EMS

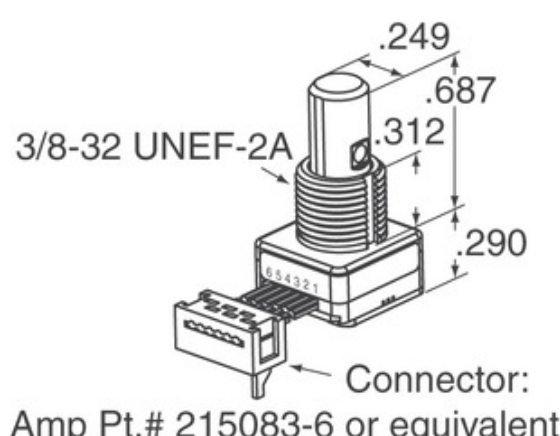
[PROŚBA O OFERTĘ](#)

Obraz może być reprezentacją. Zobacz specyfikację dla szczegółów produktu.







Specyfikacje 62S11-N4-060SH

PART NUMBER	62S11-N4-060SH
PRODUCENT	Grayhill, Inc.
OPIS	ROTARY ENCODER OPTICAL 32PPR
STAN OŁOWIU / STATUS ROHS	Bezołowiowe / Zgodny z RoHS
DOSTĘPNA ILOŚĆ	2262 pcs
ARKUSZ DANYCH	 62S11-N4-060SH.pdf
NAPIĘCIE - DOSTAWA	5V
TERMINATION STYLE	Cable Leads
SERIA	62S
CYKLE OBROTOWA NATURA (MIN)	1M
IMPULSÓW NA OBRÓT	32
TYP WYJŚCIA	Quadrature (Incremental)
INNE NAZWY	62S11N4060SH
ORIENTACJA	Vertical
RODZAJ MOCOWANIA	Panel Mount
POZIOM CZUŁOŚCI NA WILGOĆ (MSL)	1 (Unlimited)
STATUS BEZOŁOWIOWY / STATUS ROHS	Lead free / RoHS Compliant
ENCODER TYPE	Optical
SAMOBLOKUJĄCY	No
WBUDOWANY WYŁĄCZNIK	Yes
TYP URZĄDZENIA URUCHAMIAJĄCEGO	1/4" Dia Flatted End

Powiązane tagi

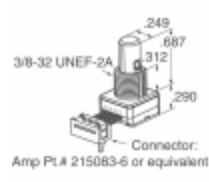
Grayhill, Inc. 62S11-N4-060SH	Dystrybutor 62S11-N4-060SH	Dostawca 62S11-N4-060SH
62S11-N4-060SH Cena	Zdjęcia 62S11-N4-060SH	Obraz 62S11-N4-060SH
Arkusz danych PDF 62S11-N4-060SH	62S11-N4-060SH Pobierz arkusz danych	Arkusz danych 62S11-N4-060SH
62S11-N4-060SH Akcje	Kup 62S11-N4-060SH	Kup Grayhill, Inc. 62S11-N4-060SH
Grayhill, Inc. 62S11-N4-060SH	Dostawca Grayhill, Inc.	Dystrybutor Grayhill, Inc.
Grayhill, Inc. 62S11-N4-060SH	Grayhill Inc. 62S11-N4-060SH	

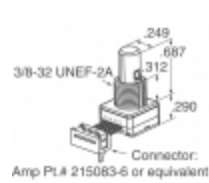
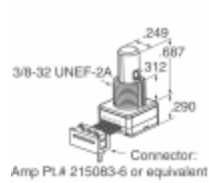
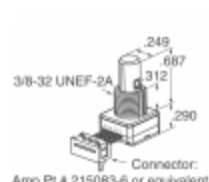
Produkty powiązane

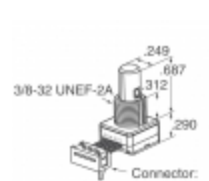
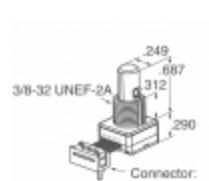
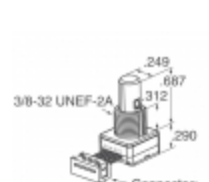
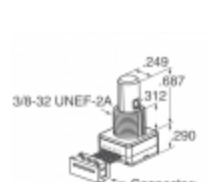
 <p>62S11-N4-025C Producenci: Grayhill, Inc. Opis: ROTARY ENCODER OPTICAL 32PPR Na stanie: 1970 pcs</p> <p>RFQ</p>	 <p>62S11-N5-025CH Producenci: Grayhill, Inc. Opis: ROTARY ENCODER OPTICAL 32PPR Na stanie: 2083 pcs</p> <p>RFQ</p>
 <p>62S11-N5-040C Producenci: Grayhill, Inc. Opis: ROTARY ENCODER OPTICAL 32PPR Na stanie: 2106 pcs</p> <p>RFQ</p>	 <p>62S11-N5-025C Producenci: Grayhill, Inc. Opis: ROTARY ENCODER OPTICAL 32PPR Na stanie: 2408 pcs</p> <p>RFQ</p>
 <p>62S11-N4-P Producenci: Grayhill, Inc. Opis: ROTARY ENCODER OPTICAL 32PPR Na stanie: 1912 pcs</p> <p>RFQ</p>	 <p>62S11-N4-120S Producenci: Grayhill, Inc. Opis: ROTARY ENCODER OPTICAL 32PPR Na stanie: 2038 pcs</p> <p>RFQ</p>
 <p>62S11-N4-PH Producenci: Grayhill, Inc. Opis: ROTARY ENCODER OPTICAL 32PPR Na stanie: 1970 pcs</p> <p>RFQ</p>	 <p>62S11-N4-020C Producenci: Grayhill, Inc. Opis: ROTARY ENCODER OPTICAL 32PPR Na stanie: 2083 pcs</p> <p>RFQ</p>
 <p>62S11-N4-025CH Producenci: Grayhill, Inc. Opis: ROTARY ENCODER OPTICAL 32PPR Na stanie: 1946 pcs</p> <p>RFQ</p>	 <p>62S11-N2-PH Producenci: Grayhill, Inc. Opis: ROTARY ENCODER OPTICAL 32PPR Na stanie: 1760 pcs</p> <p>RFQ</p>
 <p>62S11-N3-PH Producenci: Grayhill, Inc. Opis: ROTARY ENCODER OPTICAL 32PPR Na stanie: 1856 pcs</p> <p>RFQ</p>	 <p>62S11-N2-P Producenci: Grayhill, Inc. Opis: ROTARY ENCODER OPTICAL 32PPR Na stanie: 2376 pcs</p> <p>RFQ</p>

Copyright © 2020 Niezawodny dystrybutor komponentów elektronicznych

E-mail: Info@infinity-electronic.com

Adres: 17F, budynek handlowy Gaylord, 114-118 Lockhart Road, Wan Chai, Hongkong

