





Grayhill, Inc.

62S11-M9-040SH

Part Number:	62S11-M9-040SH
Producent / marka:	Grayhill, Inc.
Opis produktu	ROTARY ENCODER OPT 32PPR 4" CBL
Arkusze danych:	 62S11-M9-040SH.pdf
Status RoHS	 Bezołowiowe / Zgodny z RoHS
Stan magazynowy	1879 pcs stock
Statek z	Hongkong
Sposób wysyłki	DHL/Fedex/TNT/UPS/EMS

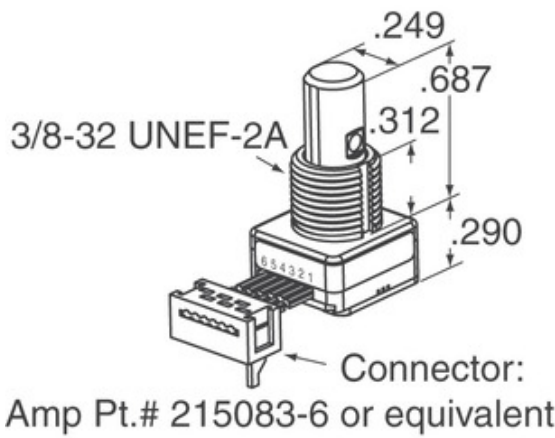
[PROŚBA O OFERTĘ](#)

Obraz może być reprezentacją. Zobacz specyfikację dla szczegółów produktu.

Specyfikacje 62S11-M9-040SH

PART NUMBER	62S11-M9-040SH
PRODUCENT	Grayhill, Inc.
OPIS	ROTARY ENCODER OPT 32PPR 4" CBL
STAN OŁOWIU / STATUS ROHS	Bezołowiowe / Zgodny z RoHS
DOSTĘPNA ILOŚĆ	1879 pcs
ARKUSZ DANYCH	 62S11-M9-040SH.pdf
NAPIĘCIE - DOSTAWA	5V
TERMINATION STYLE	Cable Leads
SERIA	62S
CYKLE OBROTOWA NATURA (MIN)	1M
IMPULSÓW NA OBRÓT	32
TYP WYJŚCIA	Quadrature (Incremental)
INNE NAZWY	Q3843894
ORIENTACJA	Vertical
RODZAJ MOCOWANIA	Panel Mount
POZIOM CZUŁOŚCI NA WILGOĆ (MSL)	1 (Unlimited)
STATUS BEZOŁOWIOWY / STATUS ROHS	Lead free / RoHS Compliant
ENCODER TYPE	Optical
SAMOBLOKUJĄCY	Yes
WBUDOWANY WYŁĄCZNIK	Yes
TYP URZĄDZENIA URUCHAMIAJĄCEGO	1/4" Dia Flatted End

Powiązane tagi

Grayhill, Inc. 62S11-M9-040SH	Dystrybutor 62S11-M9-040SH	Dostawca 62S11-M9-040SH
62S11-M9-040SH Cena	Zdjęcia 62S11-M9-040SH	Obraz 62S11-M9-040SH
Arkusz danych PDF 62S11-M9-040SH	62S11-M9-040SH Pobierz arkusz danych	Arkusz danych 62S11-M9-040SH
62S11-M9-040SH Akcje	Kup 62S11-M9-040SH	Kup Grayhill, Inc. 62S11-M9-040SH
Grayhill, Inc. 62S11-M9-040SH	Dostawca Grayhill, Inc.	Dystrybutor Grayhill, Inc.
Grayhill, Inc. 62S11-M9-040SH	Grayhill Inc. 62S11-M9-040SH	

Produkty powiązane

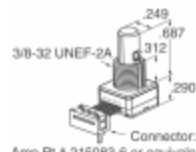
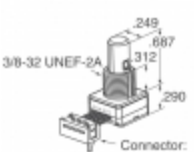
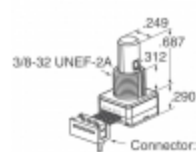
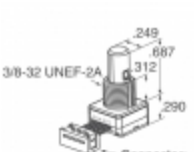
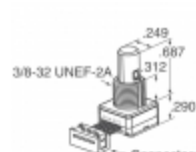
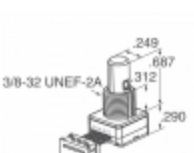
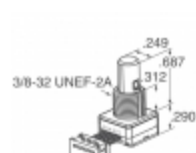
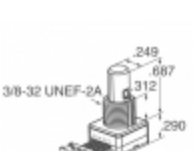
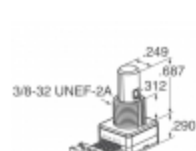
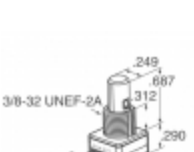
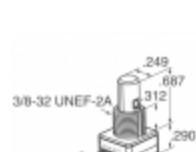
 <p>62S11-M9-020CH Producenci: Grayhill, Inc. Opis: ROTARY ENCODER OPTICAL 32PPR Na stanie: 2097 pcs</p> <p>RFQ</p>	 <p>62S11-M9-100S Producenci: Grayhill, Inc. Opis: ROTARY ENCODER OPTICAL 32PPR Na stanie: 2008 pcs</p> <p>RFQ</p>
 <p>62S11-M9-120S Producenci: Grayhill, Inc. Opis: ROTARY ENCODER OPTICAL 32PPR Na stanie: 2092 pcs</p> <p>RFQ</p>	 <p>62S11-M9-030S Producenci: Grayhill, Inc. Opis: ROTARY ENCODER OPTICAL 32PPR Na stanie: 1918 pcs</p> <p>RFQ</p>
 <p>62S11-M9-025S Producenci: Grayhill, Inc. Opis: ROTARY ENCODER OPTICAL 32PPR Na stanie: 2070 pcs</p> <p>RFQ</p>	 <p>62S11-M9-050C Producenci: Grayhill, Inc. Opis: ROTARY ENCODER OPTICAL 32PPR Na stanie: 2082 pcs</p> <p>RFQ</p>
 <p>62S11-M9-060C Producenci: Grayhill, Inc. Opis: ROTARY ENCODER OPTICAL 32PPR Na stanie: 2060 pcs</p> <p>RFQ</p>	 <p>62S11-M9-040C Producenci: Grayhill, Inc. Opis: ROTARY ENCODER OPTICAL 32PPR Na stanie: 1933 pcs</p> <p>RFQ</p>
 <p>62S11-M9-100C Producenci: Grayhill, Inc. Opis: ROTARY ENCODER OPTICAL 32PPR Na stanie: 2260 pcs</p> <p>RFQ</p>	 <p>62S11-M9-020C Producenci: Grayhill, Inc. Opis: ROTARY ENCODER OPTICAL 32PPR Na stanie: 2241 pcs</p> <p>RFQ</p>
 <p>62S11-M9-095CH Producenci: Grayhill, Inc. Opis: ROTARY ENCODER OPTICAL 32PPR Na stanie: 1978 pcs</p> <p>RFQ</p>	 <p>62S11-M9-020S Producenci: Grayhill, Inc. Opis: ROTARY ENCODER OPTICAL 32PPR Na stanie: 2269 pcs</p> <p>RFQ</p>

Copyright © 2020 Niezawodny dystrybutor komponentów elektronicznych

E-mail: Info@infinity-electronic.com

Adres: 17F, budynek handlowy Gaylord, 114-118 Lockhart Road, Wan Chai, Hongkong

