

## JENNY-T4

IESNA Type IV light distribution for wider roads and large outdoor areas. Assembly with black frame.

### TECHNICAL SPECIFICATIONS:

|                 |            |
|-----------------|------------|
| Dimensions      | 35 + 50 mm |
| Height          | 17 mm      |
| Fastening       | screw      |
| Colour          | clear      |
| Box size        |            |
| Box weight      | 0 kg       |
| Quantity in Box | 1020 pcs   |
| ROHS compliant  | yes ⓘ      |



### MATERIAL SPECIFICATIONS:

| Component       | Type      | Material | Colour |
|-----------------|-----------|----------|--------|
| JENNY-T4        | Lens      | Silicone | clear  |
| JENNY-HLD-A-BLK | Accessory | PC       | black  |

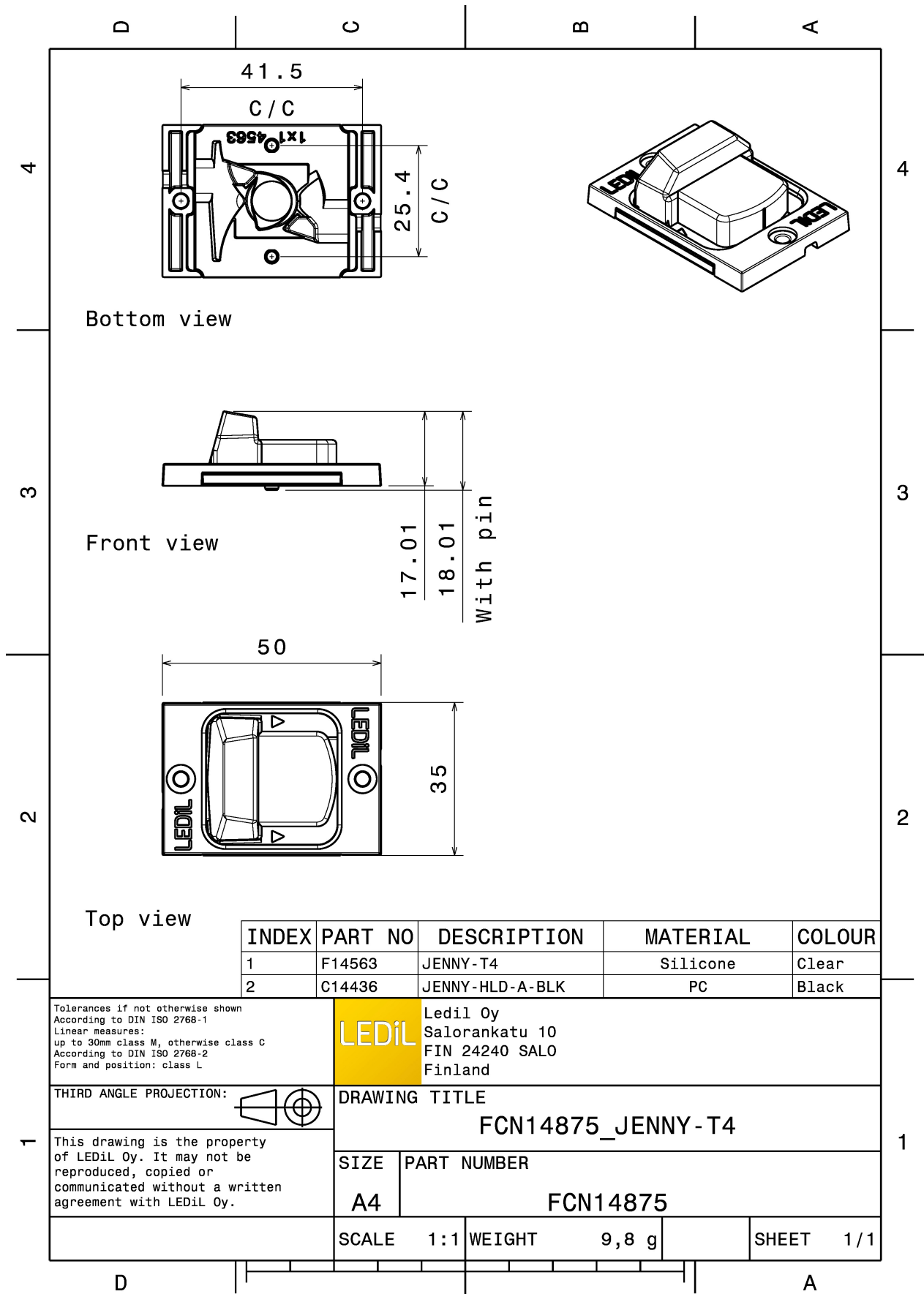

#### PHOTOMETRIC DATA (MEASURED):

bridgelux

LED V10 Gen6  
FWHM Asymmetric  
Efficiency 93 %  
Peak intensity 0.460 cd/lm  
Required components:

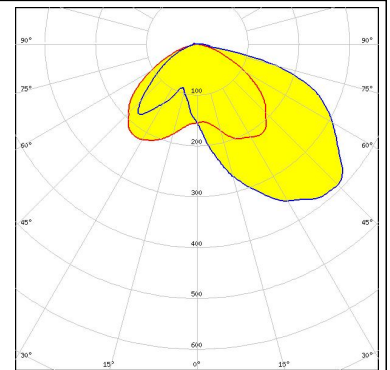

#### CITIZEN

LED CLL02x/CLU02x (LES10)  
FWHM Asymmetric  
Efficiency 93 %  
Peak intensity 0.460 cd/lm  
Required components:

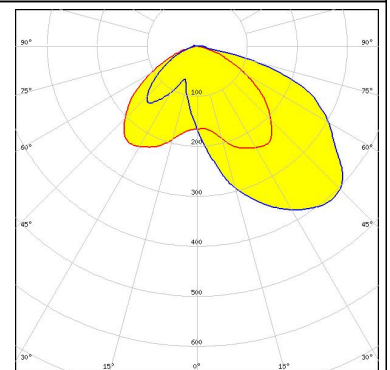

#### CREE

LED CXA/B 15xx  
FWHM Asymmetric  
Efficiency 94 %  
Peak intensity 0.480 cd/lm  
Required components:

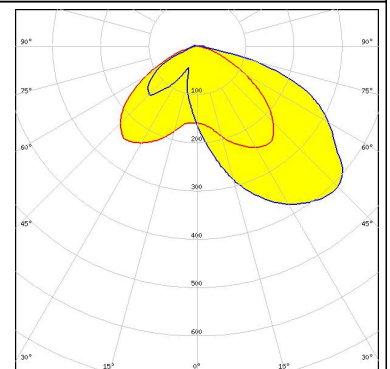

#### CREE

LED MK-R  
FWHM Asymmetric  
Efficiency 93 %  
Peak intensity 0.560 cd/lm  
Required components:

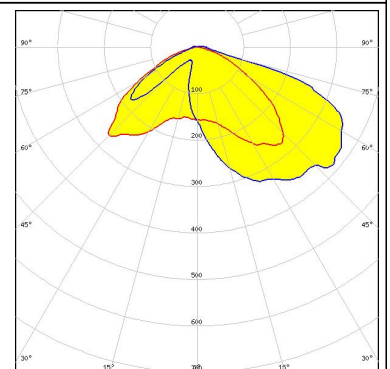

#### PHOTOMETRIC DATA (MEASURED):

#### **CREE** ⇄

LED MX-6  
FWHM Asymmetric  
Efficiency 92 %  
Peak intensity 0.610 cd/lm  
Required components:

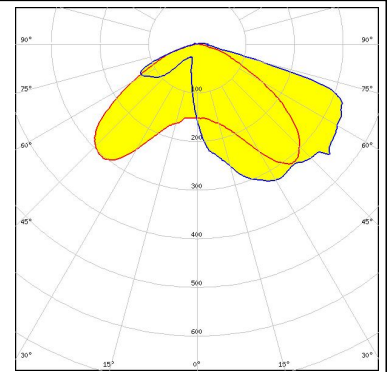

#### **CREE** ⇄

LED XHP70  
FWHM Asymmetric  
Efficiency 91 %  
Peak intensity 0.500 cd/lm  
Required components:

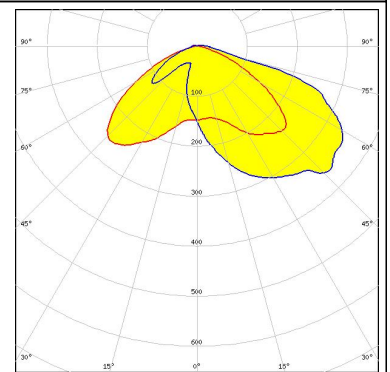

#### **CREE** ⇄

LED XM-L EZW  
FWHM Asymmetric  
Efficiency 93 %  
Peak intensity 0.680 cd/lm  
Required components:

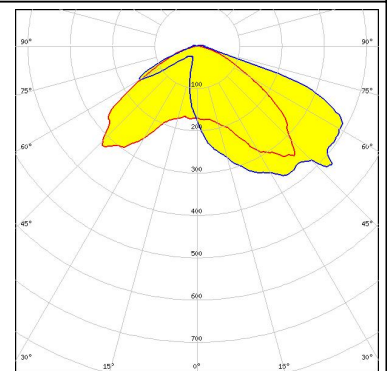

#### **LUMILEDS**

LED LUXEON M/MX  
FWHM Asymmetric  
Efficiency 94 %  
Peak intensity 0.660 cd/lm  
Required components:

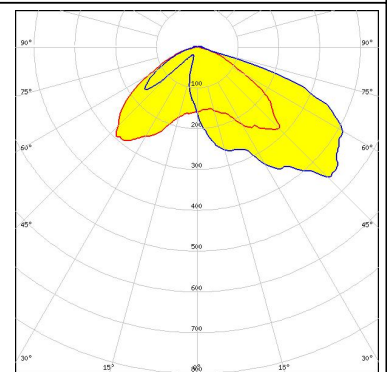

#### PHOTOMETRIC DATA (MEASURED):



LED CXM-9  
FWHM Asymmetric  
Efficiency 93 %  
Peak intensity 0.460 cd/lm  
Required components:

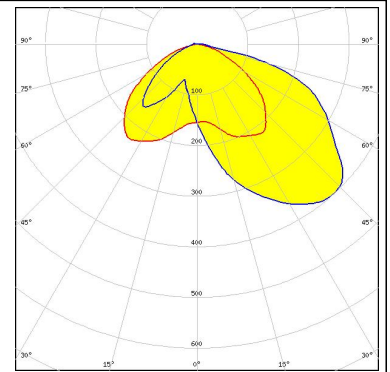

LED NV9W149AM  
FWHM Asymmetric  
Efficiency 88 %  
Peak intensity 0.440 cd/lm  
Required components:

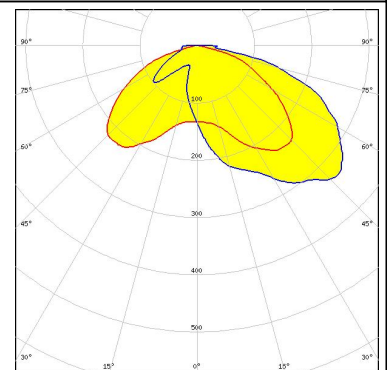



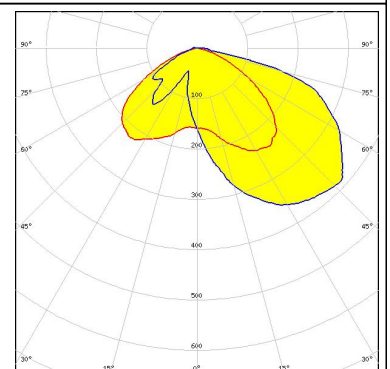



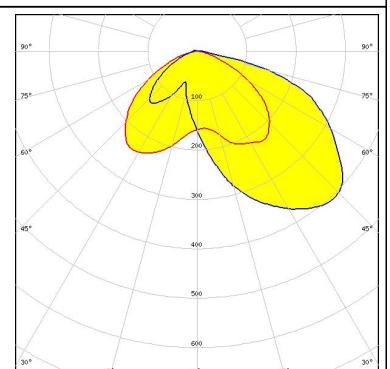

LED Soleriq P9  
FWHM Asymmetric  
Efficiency 94 %  
Peak intensity 0.470 cd/lm  
Required components:

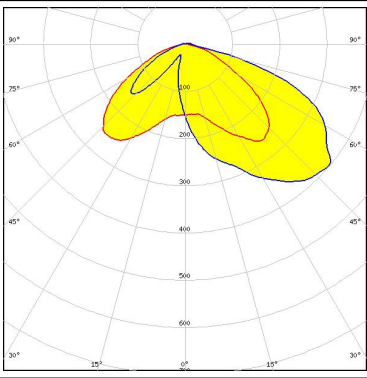

LED COB D Series LES 9.8 mm  
FWHM Asymmetric  
Efficiency 94 %  
Peak intensity 0.470 cd/lm  
Required components:

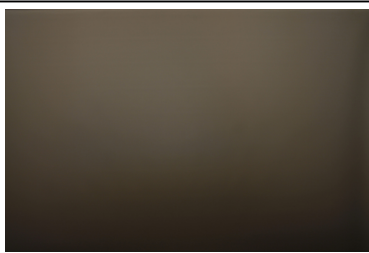
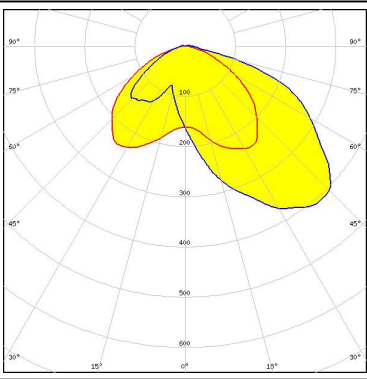

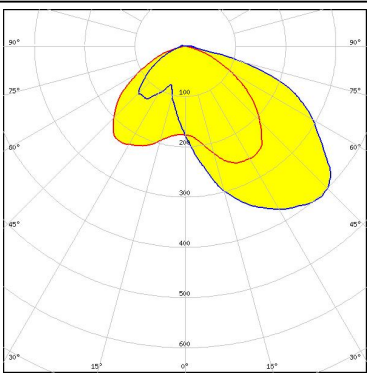
#### PHOTOMETRIC DATA (MEASURED):

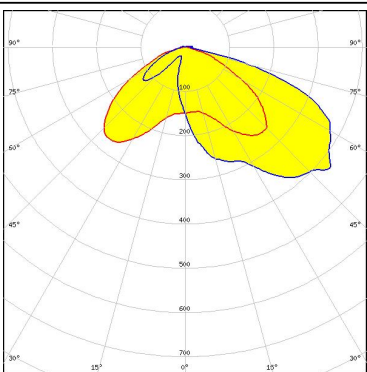
|   |  |   |
|---|--|---|
| <p><br/>SEOUL SEMICONDUCTOR</p> <p>LED MJT COB LES 6<br/>FWHM Asymmetric<br/>Efficiency 92 %<br/>Peak intensity 0.540 cd/lm<br/>Required components:</p>   |    |    |
| <p><br/>SEOUL SEMICONDUCTOR</p> <p>LED MJT COB LES 9.8<br/>FWHM Asymmetric<br/>Efficiency 94 %<br/>Peak intensity 0.470 cd/lm<br/>Required components:</p> |   |   |
| <p><b>TRIDONIC</b></p> <p>LED SLE G5 LES11<br/>FWHM Asymmetric<br/>Efficiency 92 %<br/>Peak intensity 0.450 cd/lm<br/>Required components:</p>  |  |  |
| <p><b>TRIDONIC</b></p> <p>LED SLE G5 LES6<br/>FWHM Asymmetric<br/>Efficiency 93 %<br/>Peak intensity 0.600 cd/lm<br/>Required components:</p>   |  |  |

### PHOTOMETRIC DATA (SIMULATED):

bridgelux

LED V10 Gen7  
FWHM Asymmetric  
Efficiency 93 %  
Peak intensity 0.440 cd/lm  
Required components:

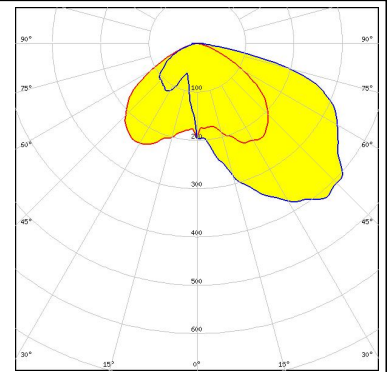

OSRAM  
Opto Semiconductors

LED OSCONIQ P 7070  
FWHM Asymmetric  
Efficiency 92 %  
Peak intensity 0.560 cd/lm  
Required components:

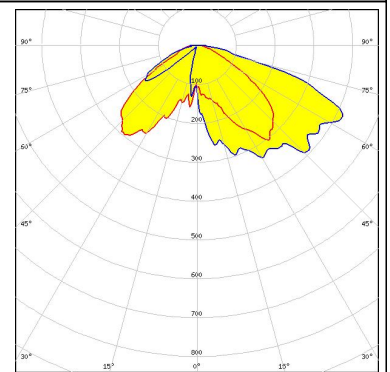



### GENERAL INFORMATION:

NOTE: The typical beam angle will be changed by different color, chip size and chip position tolerance. The typical total beam angle is the full angle measured where the luminous intensity is half of the peak value.

Due to use of high power COB's with this product, special attention to proper thermal design is highly recommended. LEDiL has no liability for direct, indirect or consecutive damages arising from the LEDiL products being used outside of the recommended temperature range.

### MATERIALS:

As part of our continuous research and improvement processes, and to ensure the best possible quality and availability of our products, LEDiL reserves the right to change material grades without notice.

### PRODUCT DATA USER AGREEMENT AND DISCLAIMER:

The measured data in the provided downloadable LEDiL Product Datasheets and Mechanical 2D-Drawings is rounded and provided as reference for planning. LEDiL Oy's optical specifications have been verified by conducting performance testing of the products in accordance with the company's quality system. The reported data are averaged results of multiple measurements with typical variation. LEDiL Oy reserves the right to without prior notification make changes and improvements to its products.

LEDiL Oy assumes neither warranty, nor guarantee nor any other liability of any kind for the contents and correctness of the provided data. The provided data has been generated with highest diligence but the provided data may in reality not represent the complete possible variation range of all intrinsic parameters. Therefore, in certain cases a deviation from the provided data could occur.

LEDiL Oy reserves the right to undertake technical changes of its products without further notification which could lead to changes in the provided data. LEDiL Oy assumes no liability of any kind for the possible deviation from any provided data or any other damage resulting from the usage of the provided data.

The user agrees to this disclaimer and user agreement with the download or usage of the provided files.

#### LEDiL Oy

Joensuunkatu 13  
FI-24240 SALO  
Finland

#### LEDiL Inc.

228 West Page Street  
Suite D  
Sycamore IL 60178  
USA

#### Local sales and technical support

[www.ledil.com/  
where\\_to\\_buy](http://www.ledil.com/where_to_buy)

#### Shipping locations

Salo, Finland  
Hong Kong, China

#### Distribution Partners

[www.ledil.com/  
where\\_to\\_buy](http://www.ledil.com/where_to_buy)