

THIS DOCUMENT IS THE PROPERTY OF
KEYSTONE ELECTRONICS CORP. AND
SHALL NOT BE REPRODUCED, DISTRIBUTED
OR USED AS A BASIS FOR MANUFACTURE
WITHOUT PRIOR WRITTEN PERMISSION
FROM KEYSTONE ELECTRONICS CORP.

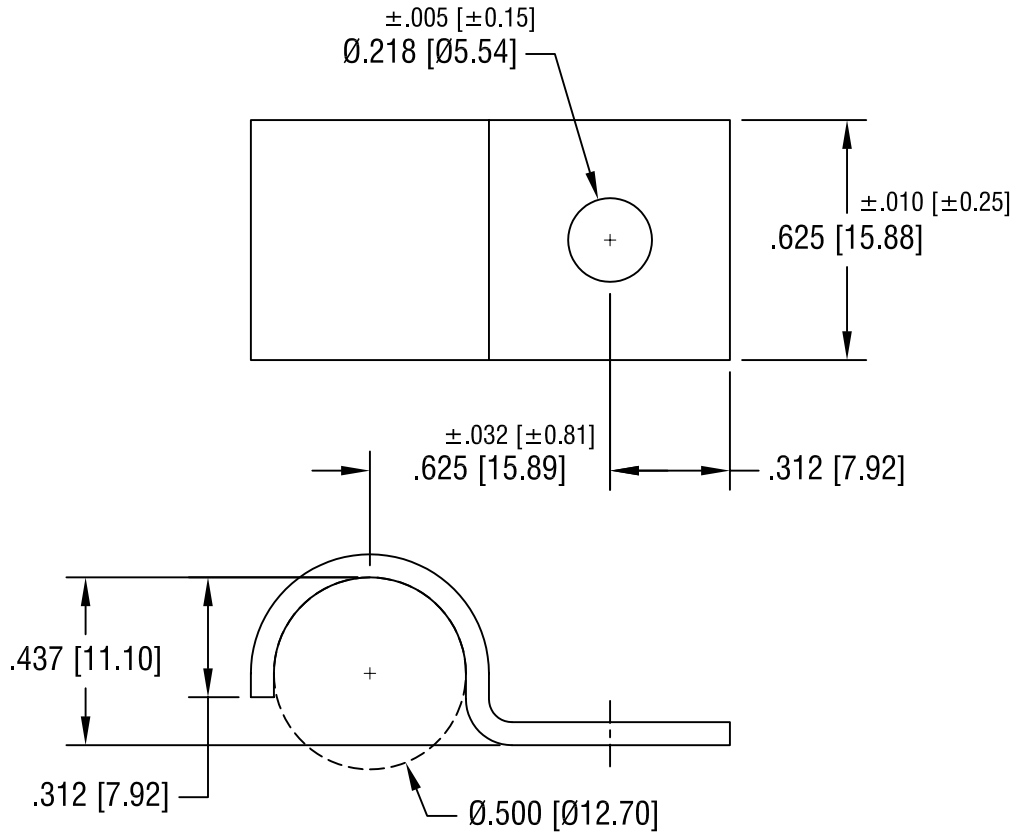

KEYSTONE ELECTRONICS CORP.

ASTORIA, N.Y. 11105-2017

PART NAME

STEEL HALF CLAMP

MATERIAL

.060 [1.52] TH'K STEEL

FINISH

ZINC PLATE
CLEAR CHROMATE

DRN BY

BOONE

DATE

1.25.00

APP'D

LN

SCALE

2X

10.18.06

CHANGE AS PER ECN 06-071

A

TOLERANCES

INCH [MM]

CODE

DWG NO.

DECIMAL $\pm .015$ [± 0.38]

C/M

ANGULAR $\pm 1^\circ$
UNLESS OTHERWISE SPECIFIED

8146

DATE

DESCRIPTION

REV.