



KU-BAND MMIC VCO WITH DIVIDE-BY-8 14 - 15 GHz

Typical Applications

Low noise MMIC VCO w/Divide-by-8 for Ku-Band applications such as:

- Point-to-Point Radios
- Point-to-Multi-Point Radios / LMDS
- VSAT

Features

- Pout: +7 dBm
- Phase Noise: -105 dBc/Hz @100 kHz Typ.
- No External Resonator Needed
- Single Supply: 5V @ 325 mA
- QSOP16G SMT Package

Functional Diagram

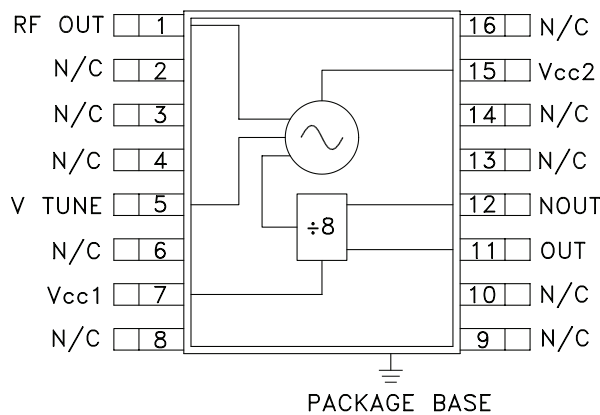

General Description

The HMC398QS16G & HMC398QS16GE are single chip GaAs InGaP Heterojunction Bipolar Transistor (HBT) MMIC VCOs. The HMC398QS16G & HMC398QS16GE integrate resonators, negative resistance devices, varactor diodes and divide-by-8 prescalers. The VCO's phase noise performance is excellent over temperature, shock, and process due to the oscillator's monolithic structure. Power output is +7 dBm typical from a 5V supply voltage. The voltage controlled oscillator is packaged in a low cost, surface mount 16 leaded QSOP package with an exposed base for improved RF and thermal performance. The HMC398QS16G & HMC398QS16GE require no external components

Electrical Specifications, $T_A = +25^\circ C$, $V_{cc1}, V_{cc2} = +5.0V$

Parameter	Min.	Typ.	Max.	Units
Frequency Range	14.0 - 15.0			GHz
Power Output	RF Output Divided Output	+3 -9	+7 -6	dBm dBm
SSB Phase Noise @ 100 kHz Offset, $V_{tune} = +5V$ @ RF Output		-105		dBc/Hz
Tune Voltage	V_{tune}	1.0	10.0	V
Supply Current	Icc 1 (Digital) Icc 2 (RF)		65 260	mA mA
Tune Port Leakage Current ($V_{tune} = 10V$)			10	μA
Output Return Loss		2		dB
Harmonics/Subharmonics	1/2 3/2 2nd 5/2		-20 -30 -12 -40	dBc dBc dBc dBc
Pulling (into a 2.0:1 VSWR)		4		MHz pp
Pushing @ $V_{tune} = 5V$		30		MHz/V
Frequency Drift Rate		1.5		MHz/ $^\circ C$

Information furnished by Analog Devices is believed to be accurate and reliable. However, no responsibility is assumed by Analog Devices for its use, nor for any infringements of patents or other rights of third parties that may result from its use. Specifications subject to change without notice. No license is granted by implication or otherwise under any patent or patent rights of Analog Devices. Trademarks and registered trademarks are the property of their respective owners.

For price, delivery, and to place orders: Analog Devices, Inc., One Technology Way, P.O. Box 9106, Norwood, MA 02062-9106
Phone: 781-329-4700 • Order online at www.analog.com
Application Support: Phone: 1-800-ANALOG-D

HMC398* PRODUCT PAGE QUICK LINKS

Last Content Update: 02/23/2017

COMPARABLE PARTS

View a parametric search of comparable parts.

EVALUATION KITS

- HMC398QS16G Evaluation Board

DOCUMENTATION

Data Sheet

- HMC398 Data Sheet

REFERENCE MATERIALS

Quality Documentation

- HMC Legacy PCN: QS##, QS##E and QS##G,QS##GE packages - Relocation of pre-existing production equipment to new building
- Package/Assembly Qualification Test Report: Plastic Encapsulated QSOP (QTR: 02015 REV: 11)
- Semiconductor Qualification Test Report: GaAs HBT-A (QTR: 2013-00228)

Technical Articles

- Low Cost Plastic MMIC VCOs

DESIGN RESOURCES

- HMC398 Material Declaration
- PCN-PDN Information
- Quality And Reliability
- Symbols and Footprints

DISCUSSIONS

View all HMC398 EngineerZone Discussions.

SAMPLE AND BUY

Visit the product page to see pricing options.

TECHNICAL SUPPORT

Submit a technical question or find your regional support number.

DOCUMENT FEEDBACK

Submit feedback for this data sheet.



**KU-BAND MMIC VCO WITH DIVIDE-BY-8
14 - 15 GHz**

VCOS - SMT

Frequency vs. Tuning Voltage, T= 25°C

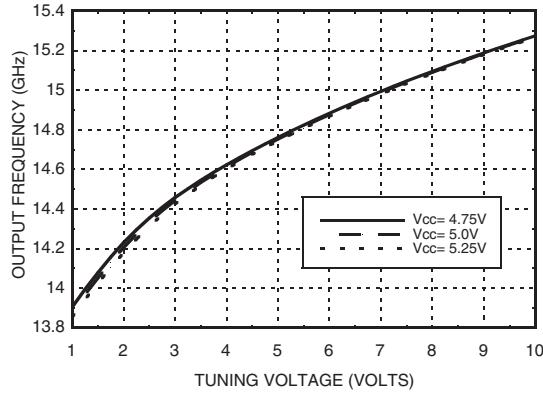

Frequency vs. Tuning Voltage, Vcc= +5V

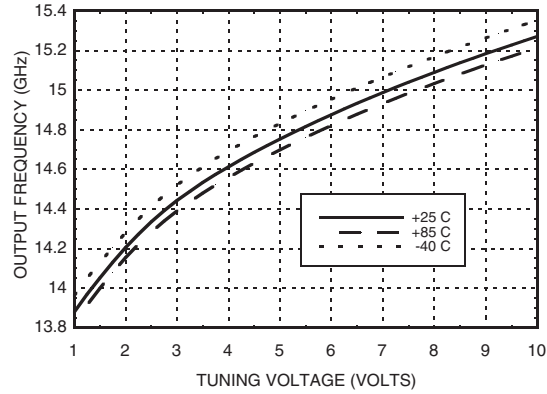

Sensitivity vs. Tuning Voltage, Vcc= +5V

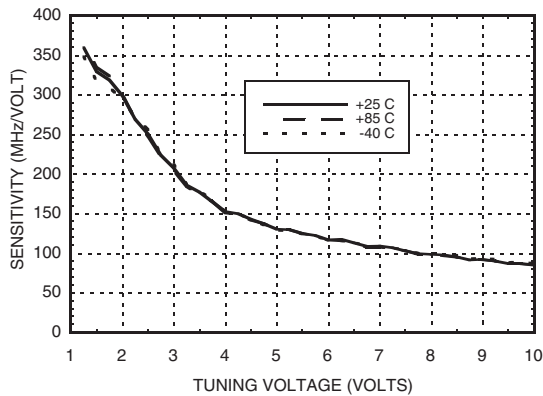

Output Power vs. Tuning Voltage, Vcc= +5V

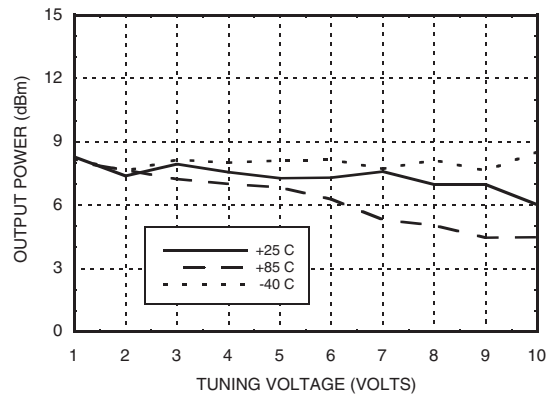

SSB Phase Noise vs. Tuning Voltage

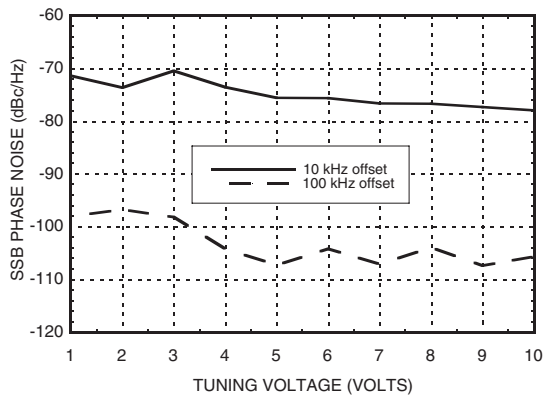

SSB Phase Noise @ Vtune= 5V

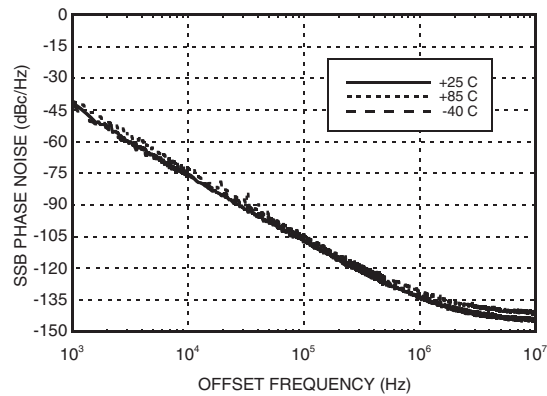

Information furnished by Analog Devices is believed to be accurate and reliable. However, no responsibility is assumed by Analog Devices for its use, nor for any infringements of patents or other rights of third parties that may result from its use. Specifications subject to change without notice. No license is granted by implication or otherwise under any patent or patent rights of Analog Devices. Trademarks and registered trademarks are the property of their respective owners.

For price, delivery, and to place orders: Analog Devices, Inc., One Technology Way, P.O. Box 9106, Norwood, MA 02062-9106 Phone: 781-329-4700 • Order online at www.analog.com Application Support: Phone: 1-800-ANALOG-D

KU-BAND MMIC VCO WITH DIVIDE-BY-8 14 - 15 GHz



**Divided Output
Frequency vs. Tuning Voltage, Vcc= +5V**

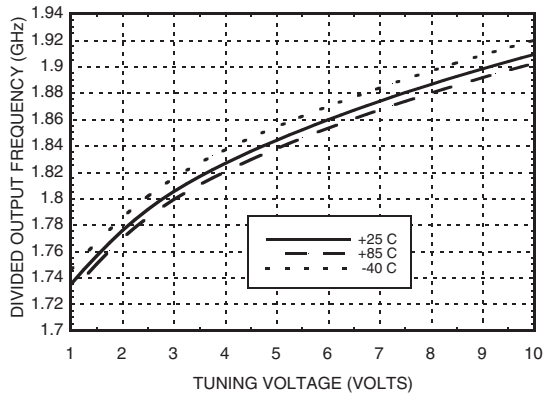

**Divided Output
Power vs. Tuning Voltage, Vcc= +5V***

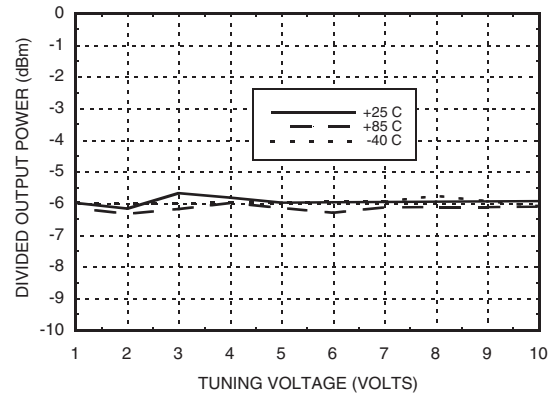

**Divided Output
SSB Phase Noise @ Vtune = 5V**

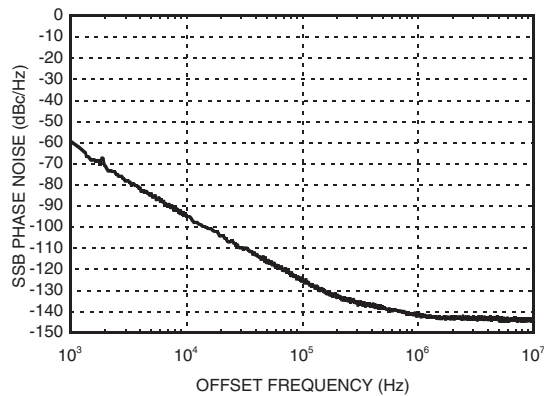

Absolute Maximum Ratings

Vcc1, Vcc2	+5.5
Storage Temperature	-65 to +150 °C
Operating Temperature	-40 to +85 °C
Vtune	0 to 11V

Typical Supply Current vs. Vcc

Vcc (V)	Icc (mA)
4.75	300
5.0	325
5.25	350

Note: VCO will operate over full voltage range shown above.



**ELECTROSTATIC SENSITIVE DEVICE
OBSERVE HANDLING PRECAUTIONS**

*Note: Tuning voltage must not drop below 1.0V for proper divider output.



Outline Drawing

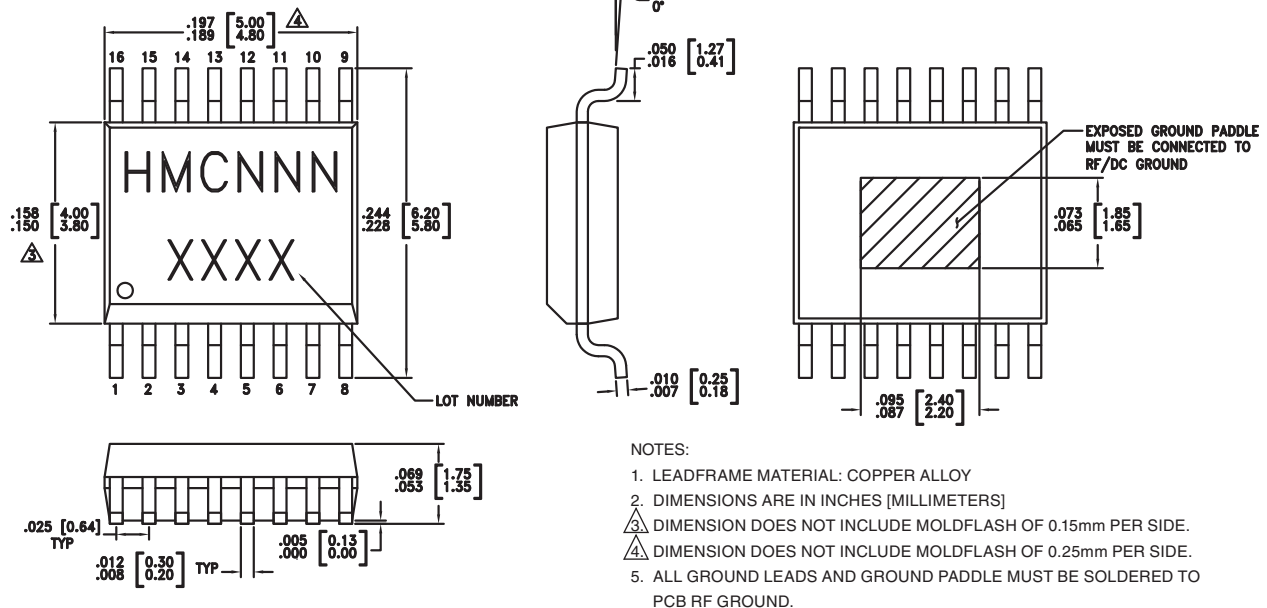

Package Information

Part Number	Package Body Material	Lead Finish	MSL Rating	Package Marking ^[3]
HMC398QS16G	Low Stress Injection Molded Plastic	Sn/Pb Solder	MSL1 ^[1]	HMC398 XXXX
HMC398QS16GE	RoHS-compliant Low Stress Injection Molded Plastic	100% matte Sn	MSL1 ^[2]	HMC398 XXXX

[1] Max peak reflow temperature of 235 °C
 [2] Max peak reflow temperature of 260 °C
 [3] 4-Digit lot number XXXX

Pin Descriptions

Pin Number	Function	Description	Interface Schematic
1	RFOUT	RF output (AC coupled).	
2, 3, 4, 6, 8, 9, 10, 13, 14, 16	N/C	No Connection	
5	VTUNE	Control Voltage Input. Modulation port bandwidth dependent on drive source impedance.	



**KU-BAND MMIC VCO WITH DIVIDE-BY-8
14 - 15 GHz**

Pin Descriptions

Pin Number	Function	Description	Interface Schematic
7, 15	VCC1, VCC2	Supply Voltage, 5V	
11	OUT	Divided Output	
12	NOUT	Divided Output 180° output phase with pin 11.	
	GND	Package bottom has an exposed metal paddle that must be RF & DC grounded.	

Typical Application Circuit

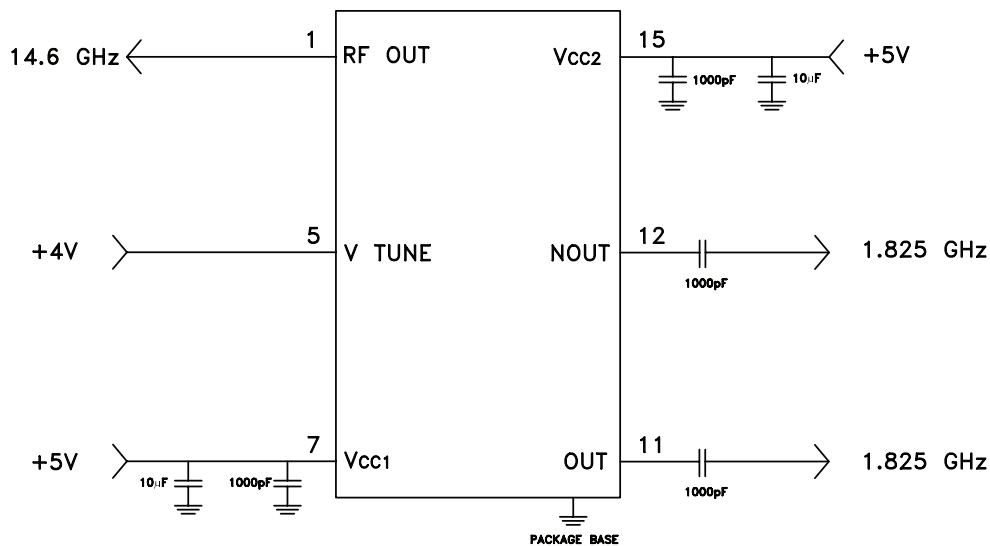

Information furnished by Analog Devices is believed to be accurate and reliable. However, no responsibility is assumed by Analog Devices for its use, nor for any infringements of patents or other rights of third parties that may result from its use. Specifications subject to change without notice. No license is granted by implication or otherwise under any patent or patent rights of Analog Devices. Trademarks and registered trademarks are the property of their respective owners.

For price, delivery, and to place orders: Analog Devices, Inc., One Technology Way, P.O. Box 9106, Norwood, MA 02062-9106 Phone: 781-329-4700 • Order online at www.analog.com Application Support: Phone: 1-800-ANALOG-D



Evaluation PCB

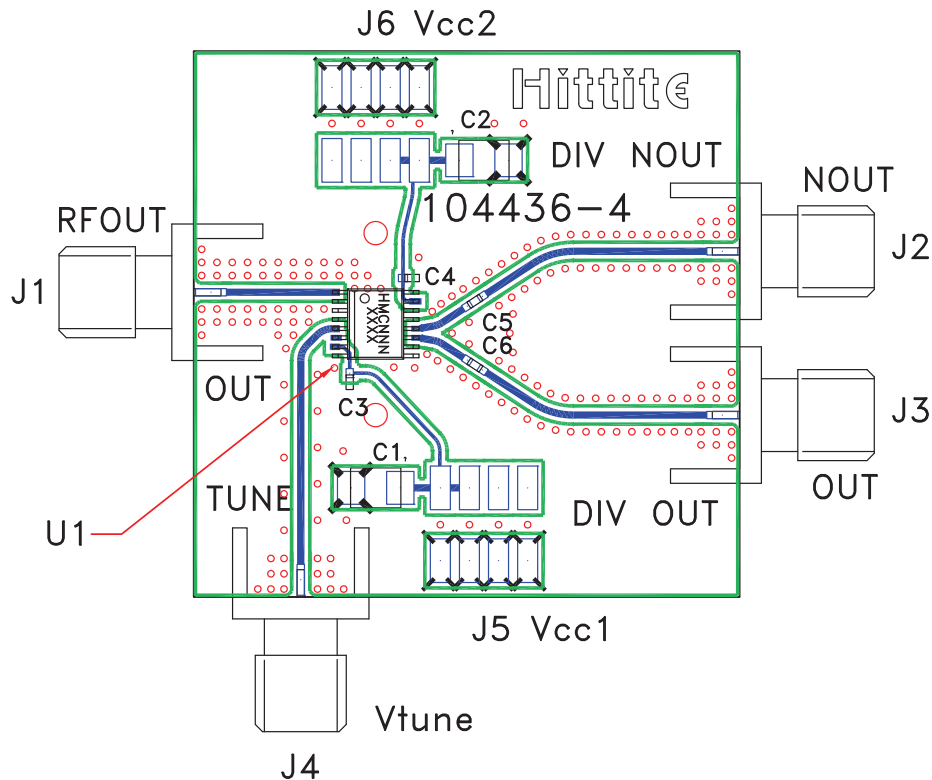

List of Materials for Evaluation PCB 104711 [1]

Item	Description
J1 - J4	PCB Mount SMA RF Connector
J5 - J6	2 mm DC Header
C1 - C2	10 μ F Tantalum Capacitor
C3 - C6	1,000 pF Capacitor 0402 Pkg.
U1	HMC398QS16G / HMC398QS16GE VCO
PCB [2]	104436 Eval Board

[1] Reference this number when ordering complete evaluation PCB

[2] Circuit Board Material: Rogers 4350

The circuit board used in the application should use RF circuit design techniques. Signal lines should have 50 Ohm impedance while the package ground leads and backside ground slug should be connected directly to the ground plane similar to that shown. A sufficient number of via holes should be used to connect the top and bottom ground planes. The evaluation circuit board shown is available from Hittite upon request.