

LOW DROPOUT VOLTAGE REGULATOR

■ GENERAL DESCRIPTION

The NJM2886 is low dropout voltage regulator designed for portable application.

Advanced Bipolar technology achieves low noise, high ripple rejection and low quiescent current.

■ PACKAGE OUTLINE

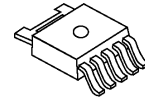

NJM2886DL3

■ FEATURES

- High Ripple Rejection 75dB typ. (f=1kHz,Vo=3V Version)
- Output Noise Voltage Vno=45μVrms typ.
- Output capacitor with 2.2μF ceramic capacitor (Vo≥2.7V)
- Output Current Io(max.)=500mA
- High Precision Output Vo±1.0%
- Low Dropout Voltage 0.18V typ. (Io=300mA)
- ON/OFF Control
- Internal Short Circuit Current Limit
- Internal Thermal Overload Protection
- Bipolar Technology
- Package Outline TO-252-5(DL3)

■ PIN CONFIGURATION

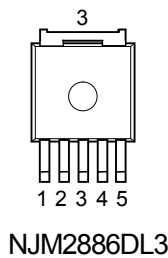

PIN FUNCTION	
1.	CONTROL
2.	V _{IN}
3.	GND
4.	V _{OUT}
5.	NC

■ BLOCK DIAGRAM

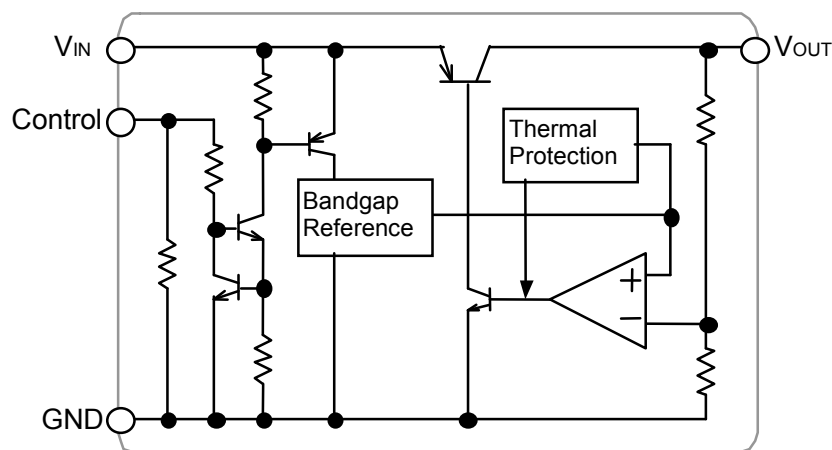

NJM2886

OUTPUT VOLTAGE RANK LIST

Device Name	V _{OUT}	Device Name	V _{OUT}	Device Name	V _{OUT}
NJM2886DL3-15	1.5V	NJM2886DL3-28	2.8V	NJM2886DL3-06	6.0V
NJM2886DL3-18	1.8V	NJM2886DL3-03	3.0V		
NJM2886DL3-19	1.9V	NJM2886DL3-33	3.3V		
NJM2886DL3-21	2.1V	NJM2886DL3-35	3.5V		
NJM2886DL3-25	2.5V	NJM2886DL3-38	3.8V		
NJM2886DL3-26	2.6V	NJM2886DL3-05	5.0V		

ABSOLUTE MAXIMUM RATINGS (Ta=25°C)

PARAMETER	SYMBOL	RATINGS	UNIT
Input Voltage	V _{IN}	+14	V
Control Voltage	V _{CONT}	+14(*1)	V
Power Dissipation	P _D	1190(*2) 3125(*3)	mW
Operating Temperature	T _{opr}	-40 ~ +85	°C
Storage Temperature	T _{stg}	-40 ~ +150	°C

(*1): When input voltage is less than +14V, the absolute maximum control voltage is equal to the input voltage.

(*2): Mounted on glass epoxy board. (76.2 × 114.3 × 1.6mm:based on EIA/JDEC standard size, 2Layers, Cu area 100mm²)

(*3): Mounted on glass epoxy board. (76.2 × 114.3 × 1.6mm:based on EIA/JDEC standard, 4Layers)

(For 4Layers: Applying 74.2 × 74.2mm inner Cu area and a thermal via hole to a board based on JEDEC standard JESD51-5)

Operating Voltage

V_{IN}=+2.3V ~ +14.0V (In case of Vo<2.1V)

ELECTRICAL CHARACTERISTICS

(V_{IN}=Vo+1V, C_{IN}=0.33μF, Co=2.2μF: Vo≥2.7V (Co=4.7μF: 1.7V<Vo≤2.6V, Co=10μF: Vo≤1.7V), Ta=25°C)

PARAMETER	SYMBOL	TEST CONDITION	MIN.	TYP.	MAX.	UNIT
Output Voltage	Vo	Io=30mA	-1.0%	-	+1.0%	V
Quiescent Current	I _Q	Io=0mA, Vo≤5.0V	-	200	300	μA
		Io=0mA, Vo>5.0V	-	215	315	
Quiescent Current at Control OFF	I _{Q(OFF)}	V _{CONT} =0V	-	-	100	nA
Output Current	Io	Vo-0.3V	500	650	-	mA
Line Regulation	ΔVo/ΔV _{IN}	V _{IN} =Vo+1V ~ Vo+6.0V, Io=30mA	-	-	0.10	%/V
Load Regulation	ΔVo/ΔIo	Io=0 ~ 500mA	-	-	0.03	%/mA
Dropout Voltage(*4)	ΔV _{L-O}	Io=300mA	-	0.18	0.28	V
Ripple Rejection	RR	ein=200mVrms, f=1kHz, Io=10mA Vo=3.0V Version	-	75	-	dB
Average Temperature Coefficient of Output Voltage	ΔVo/ΔTa	Ta=0~85°C, Io=10mA	-	±50	-	ppm/°C
Output Noise Voltage	V _{NO}	f=10Hz~80kHz, Io=10mA, Vo=3.0V Version	-	45	-	μVrms
Control Voltage for ON-state	V _{CONT(ON)}		1.6	-	-	V
Control Voltage for OFF-state	V _{CONT(OFF)}		-	-	0.6	V

(*4):The output voltage excludes under 2.1V.

The above specification is a common specification for all output voltages.

Therefore, it may be different from the individual specification for a specific output voltage.

POWER DISSIPATION VS. AMBIENT TEMPERATURE

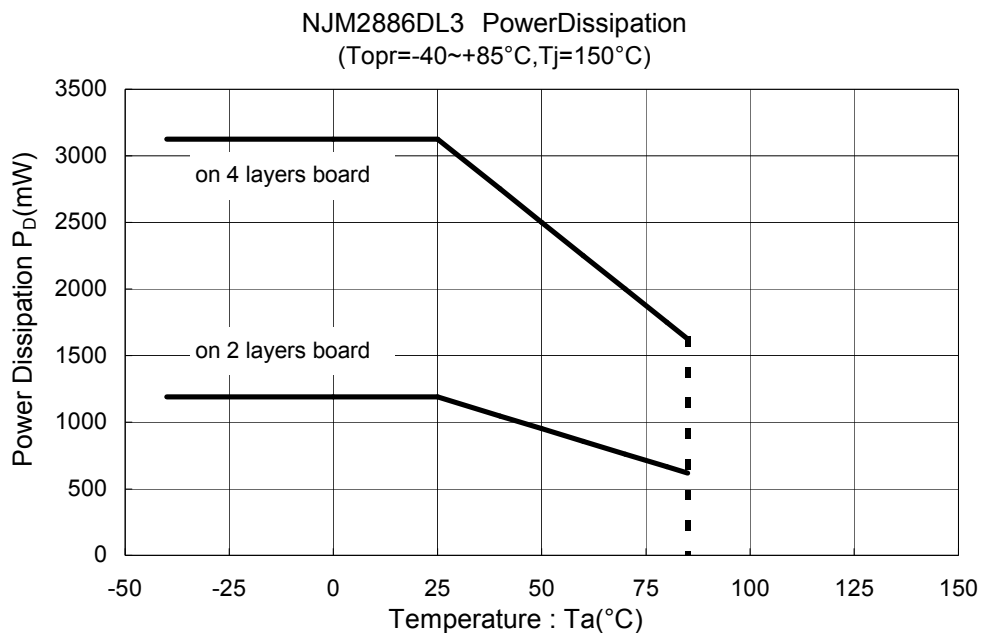

TEST CIRCUIT

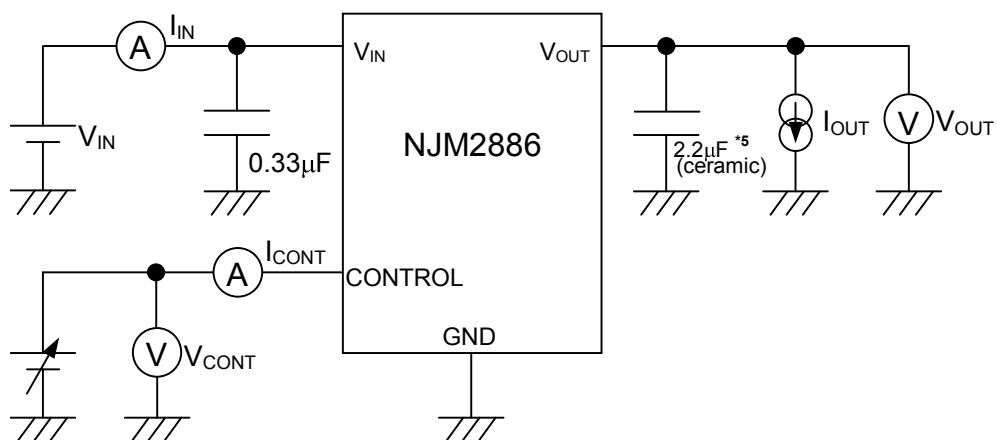

*5 1.7V < V_o ≤ 2.6V version: $C_o=4.7\mu\text{F}$ (ceramic)
 $V_o \leq 1.7\text{V}$ version: $10\mu\text{F}$ (ceramic)

NJM2886

■ TYPICAL APPLICATION

① In the case where ON/OFF Control is not required:

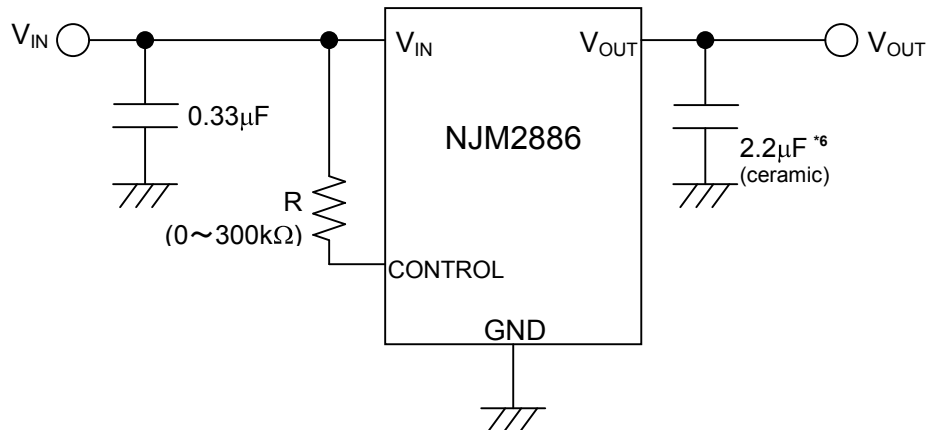

*6 1.7V $V_o \le 2.6V$ version: $C_o = 4.7\mu F$
 $V_o \le 1.7V$ version: $10\mu F$

Connect control terminal to V_{IN} terminal

② In use of ON/OFF CONTROL:

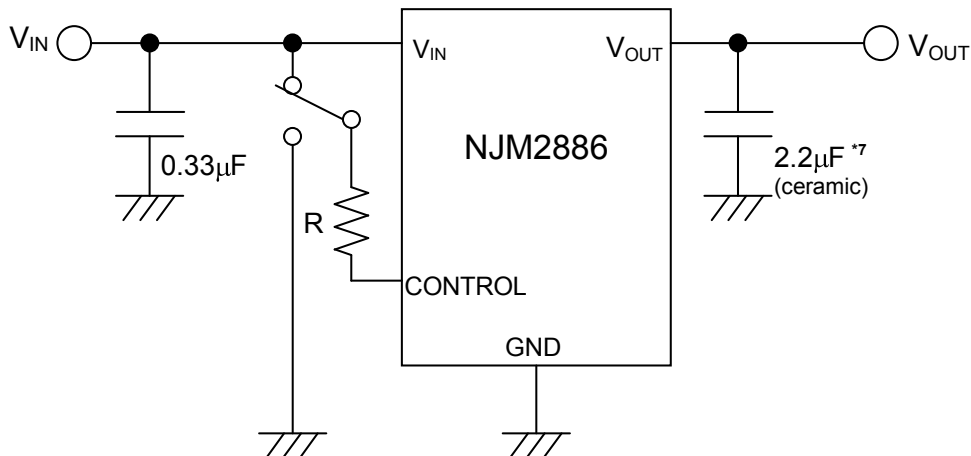

*7 1.7V $V_o \le 2.6V$ version: $C_o = 4.7\mu F$ (ceramic)
 $V_o \le 1.7V$ version: $10\mu F$ (ceramic)

State of control terminal:

- "H" → output is enabled.
- "L" or "open" → output is disabled.

*In the case of using a resistance "R" between V_{IN} and control.

If this resistor is inserted, it can reduce the control current when the control voltage is high.

The applied voltage to control terminal should set to consider voltage drop through the resistor "R" and the minimum control voltage for ON-state.

The $V_{CONT(ON)}$ and I_{CONT} have temperature dependence as shown in the "Control Current vs. Temperature" and "Control Voltage vs. Temperature" characteristics. Therefore, the resistance "R" should be selected to consider the temperature characteristics.

*Input Capacitor C_{IN}

Input Capacitor C_{IN} is required to prevent oscillation and reduce power supply ripple for applications when high power supply impedance or a long power supply line.

Therefore, use the recommended C_{IN} value (refer to conditions of ELECTRIC CHARACTERISTIC) or larger and should connect between GND and V_{IN} as shortest path as possible to avoid the problem.

*Output Capacitor C_O

Output capacitor (C_O) will be required for a phase compensation of the internal error amplifier.

The capacitance and the equivalent series resistance (ESR) influence to stable operation of the regulator.

Use of a smaller C_O may cause excess output noise or oscillation of the regulator due to lack of the phase compensation.

On the other hand, Use of a larger C_O reduces output noise and ripple output, and also improves output transient response when rapid load change.

Therefore, use the recommended C_O value (refer to conditions of ELECTRIC CHARACTERISTIC) or larger and should connect between GND and V_{OUT} as shortest path as possible for stable operation

The recommended capacitance depends on the output voltage rank. Especially, low voltage regulator requires larger C_O value.

In addition, you should consider varied characteristics of capacitor (a frequency characteristic, a temperature characteristic, a DC bias characteristic and so on) and unevenness peculiar to a capacitor supplier enough.

When selecting C_O , recommend that have withstand voltage margin against output voltage and superior temperature characteristic though this product is designed stability works with wide range ESR of capacitor including low ESR products.

NJM2886

ELECTRICAL CHARACTERISTICS

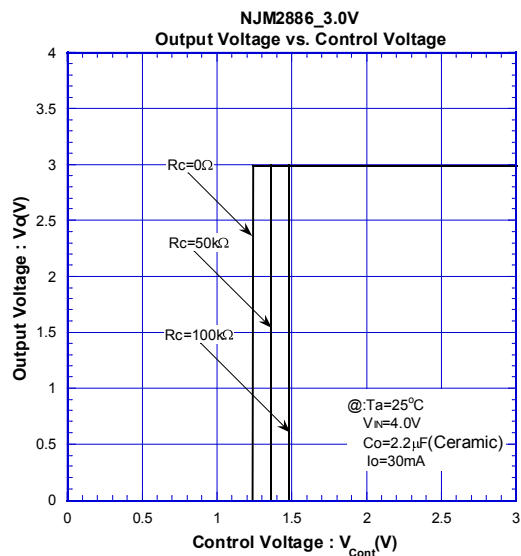
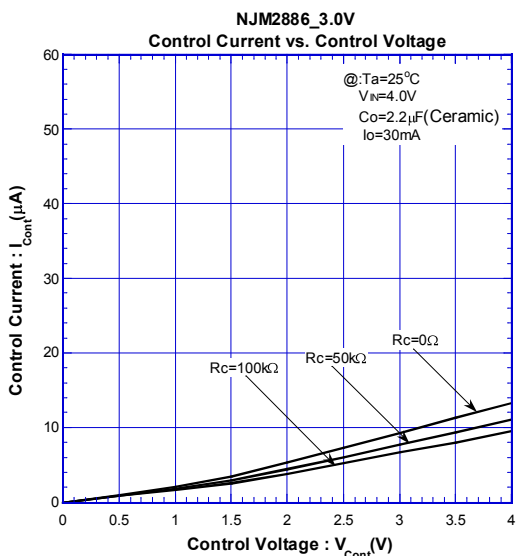
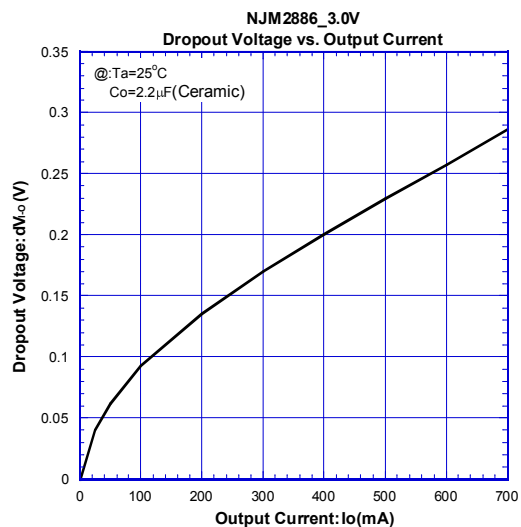
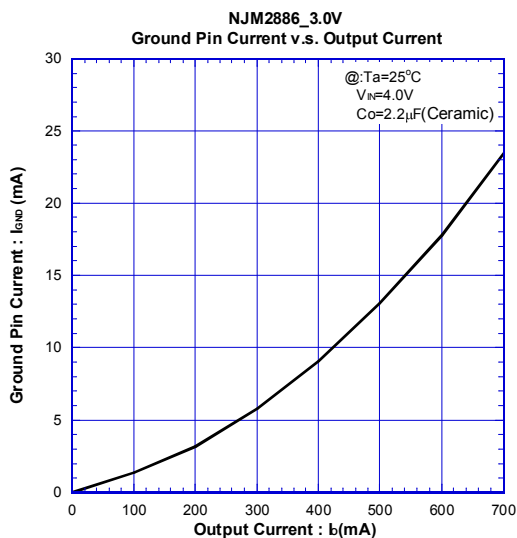
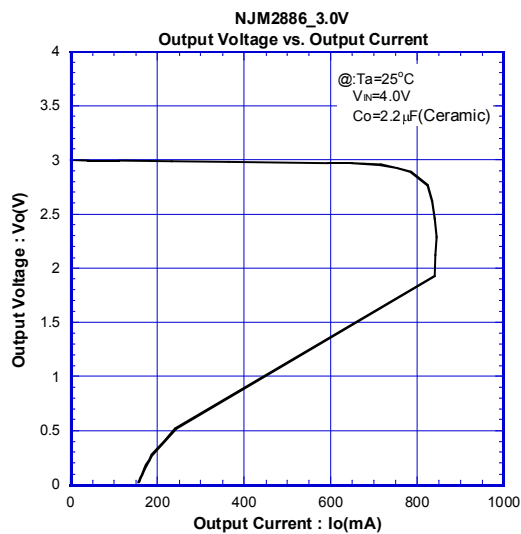
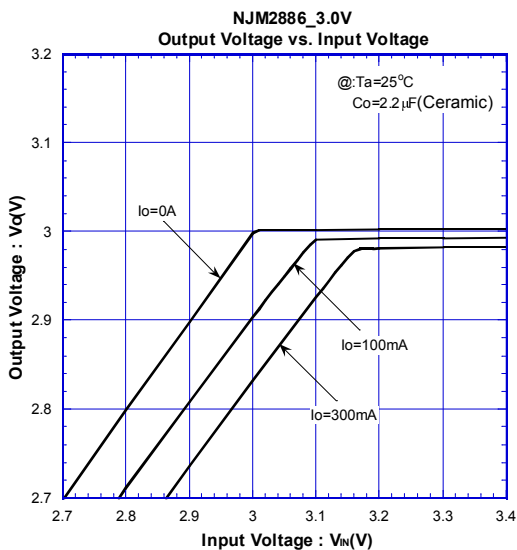

ELECTRICAL CHARACTERISTICS

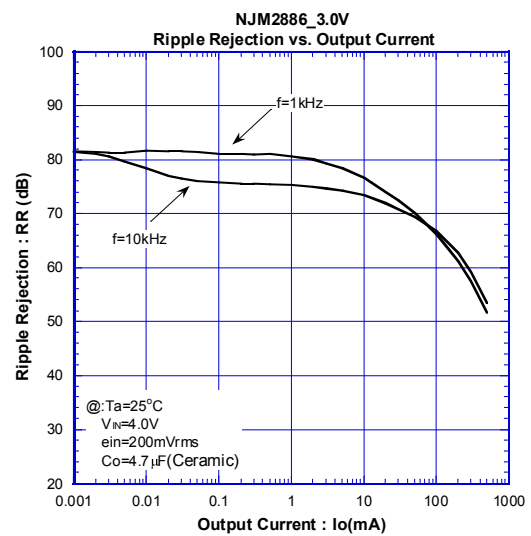
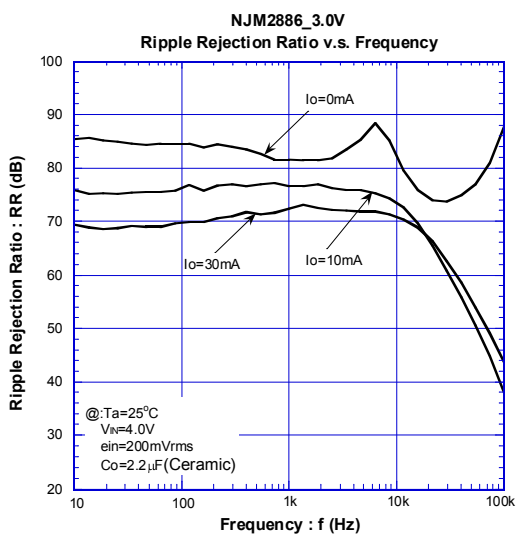
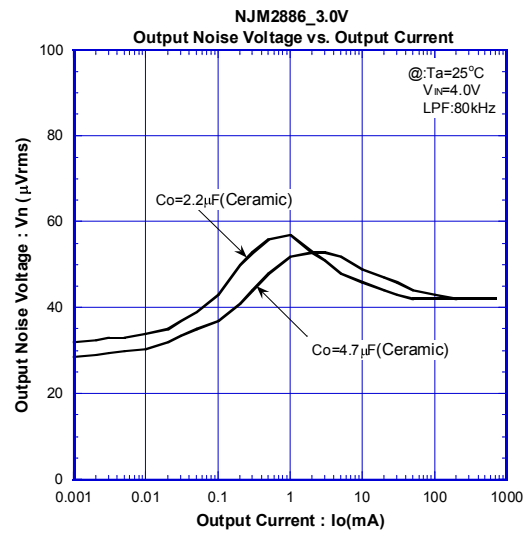
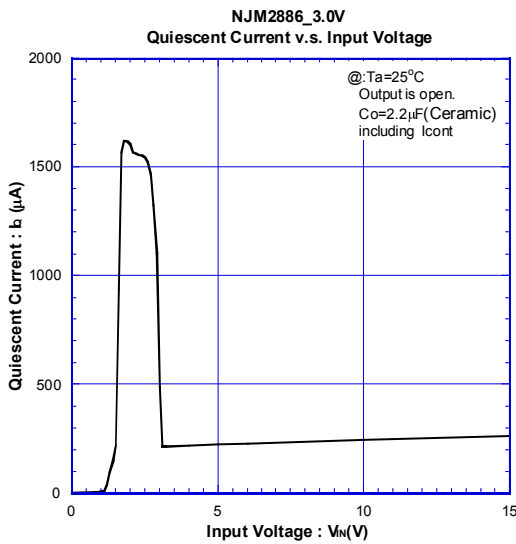
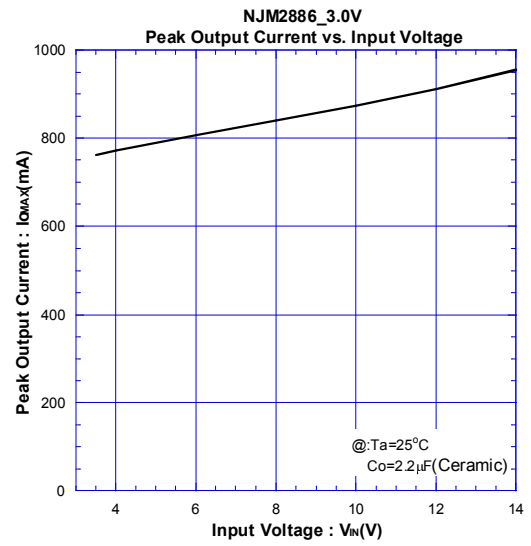
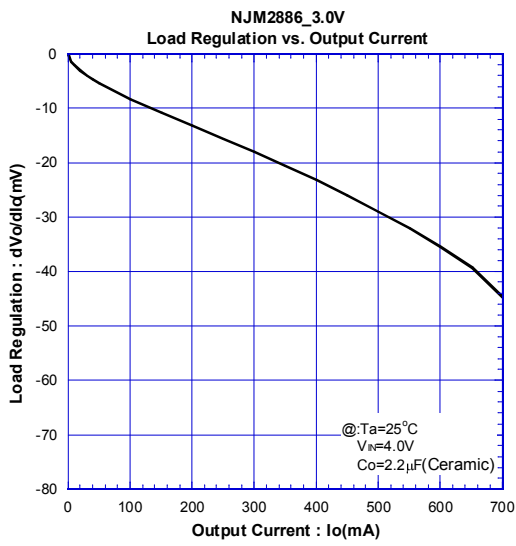

NJM2886

ELECTRICAL CHARACTERISTICS

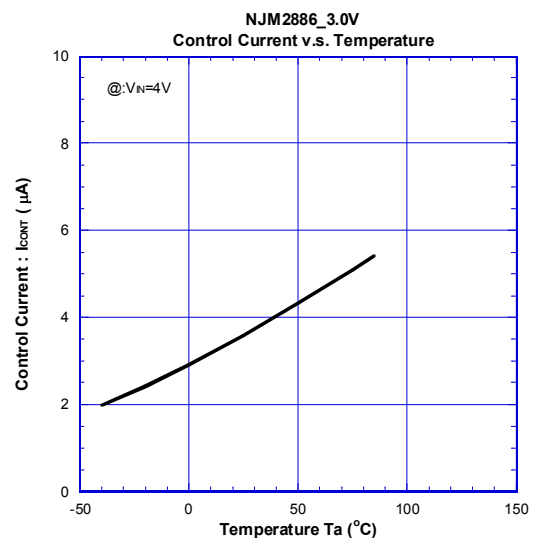
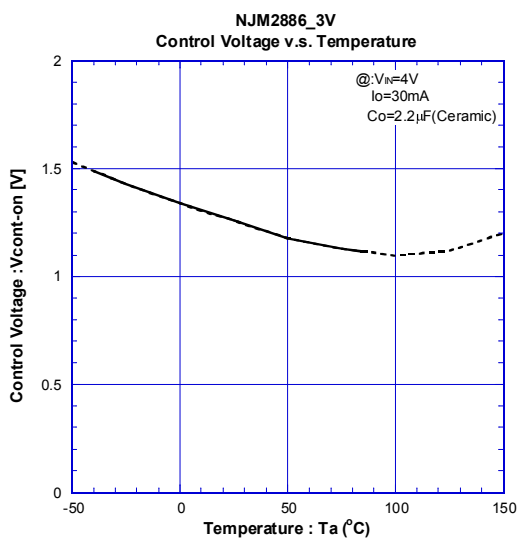
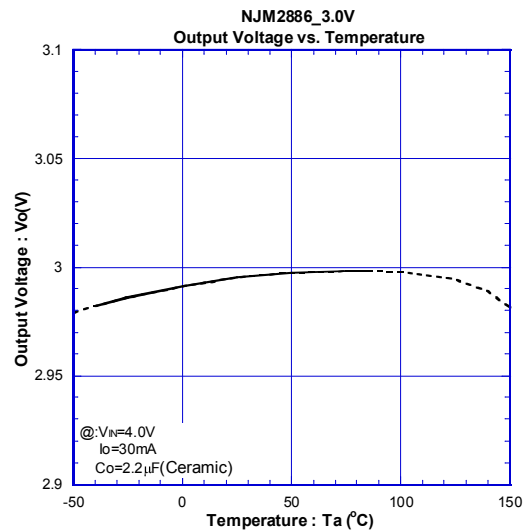
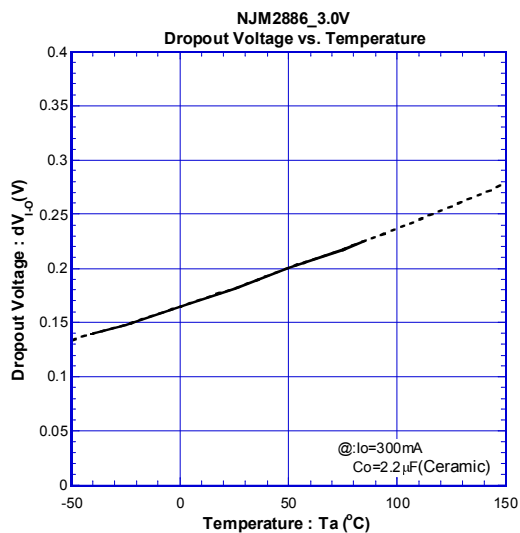
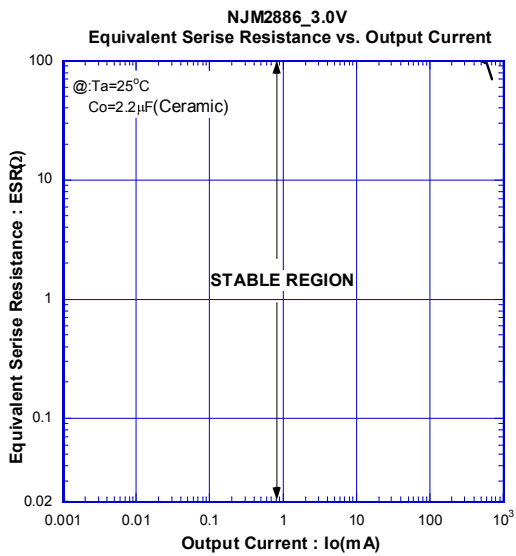

ELECTRICAL CHARACTERISTICS

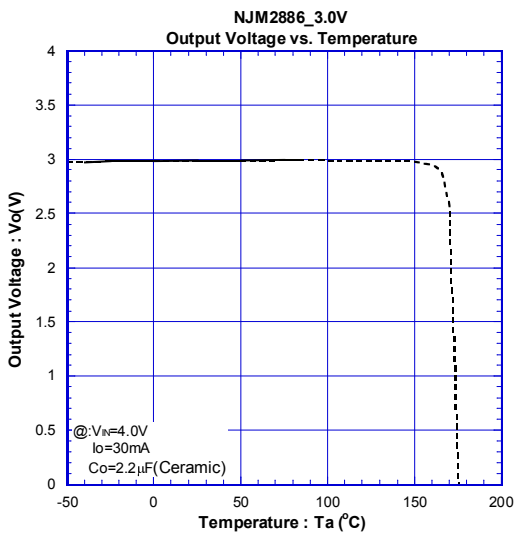
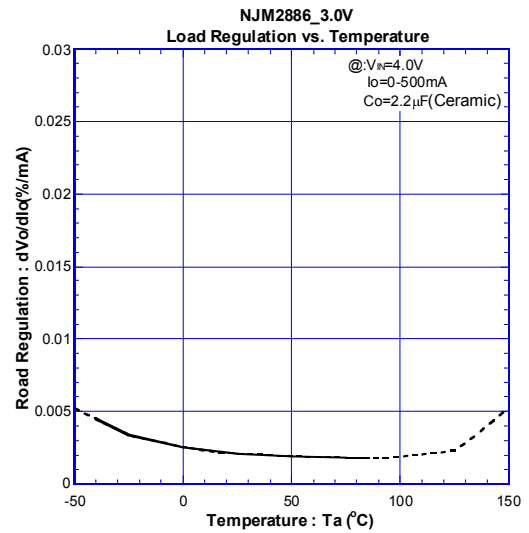
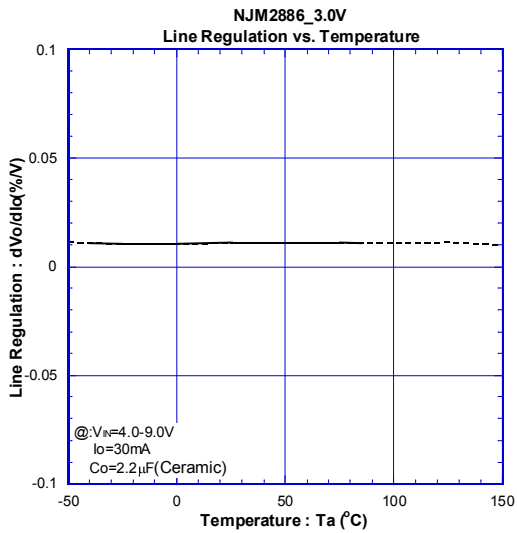
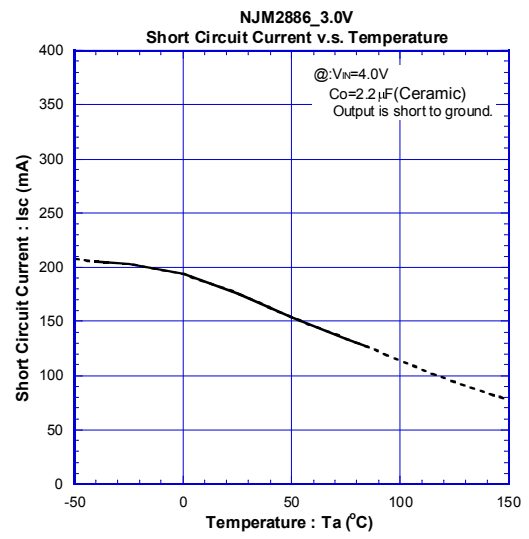
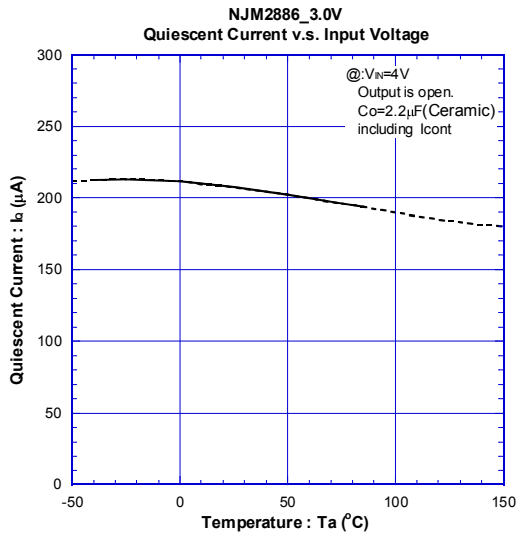

ELECTRICAL CHARACTERISTICS

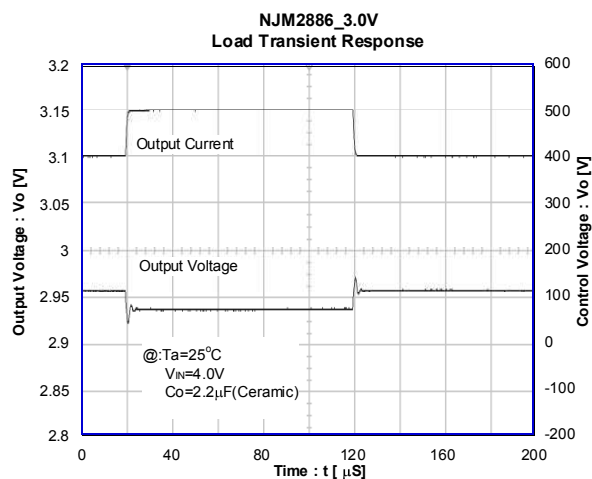
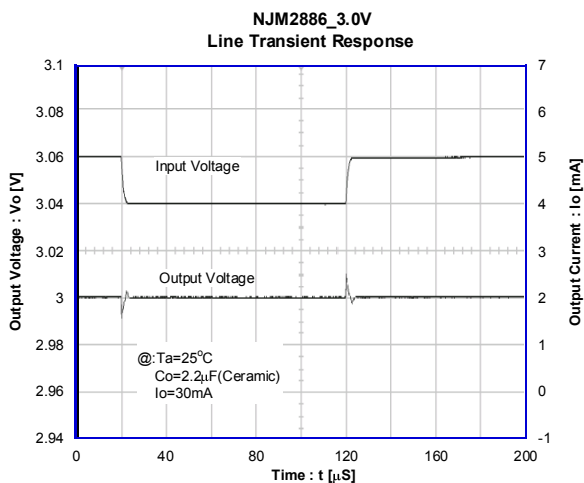
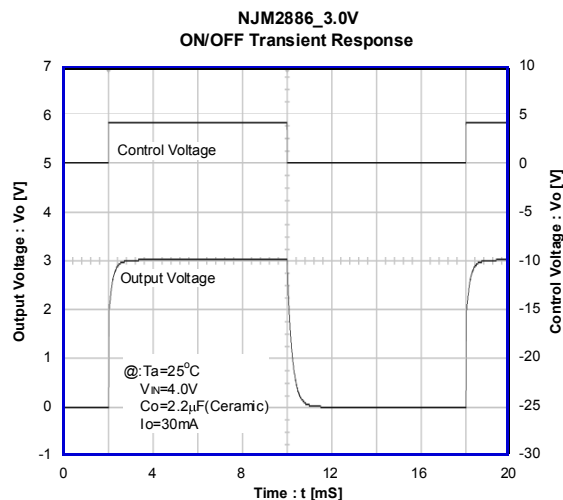
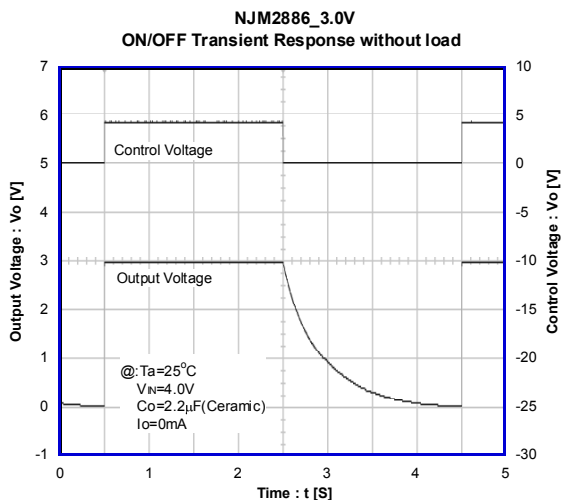

[CAUTION]

The specifications on this databook are only given for information, without any guarantee as regards either mistakes or omissions. The application circuits in this databook are described only to show representative usages of the product and not intended for the guarantee or permission of any right including the industrial rights.