

Laser Photoelectric Sensor

E3L

Prewired DC Sensor Provides Long-Distance Sensing of Objects as Small as 0.1 mm

- Detect small objects over longer sensing distances with highly accurate positioning
- Attachable apertures allow detection down to 0.1 mm diameter
- Alarm output signals deteriorating detection conditions due to improper alignment or dust contamination
- Class I (FDA/IEC) laser product E3L-50, requires no additional protective equipment
- Visible spot through-beam version aids in critical alignment applications



Ordering Information

■ SENSORS

Method of detection		Through-beam		Diffuse reflective
Sensing distance		10 m (32.8 ft)	2 m (6.56 ft)	20 to 50 cm (7.9 to 19.7 in)
Light source		Visible red	Infrared	Infrared
Laser class		Class II	Class I	Class I
Part number	NPN output	E3L-2RC4	E3L-2E4-50	E3L-DS50E4-50
	PNP output	—	E3L-2B4-50	—

■ REPLACEMENT PARTS

Description		Part number
Mounting bracket	For through-beam type; supplied with E3L-2□4- 50, E3L-2RC4	E39-L6
	For diffuse reflective type; supplied with E3L-DS50E4-50	E39-L5
Sensitivity adjuster knob		E39-G1
Apertures for through-beam types	Aperture with 0.85 mm dia. opening	E39-S56
	Aperture with 0.10 mm dia. opening	E39-S55

Specifications

Part number		E3L-2RC4 (See Note.)	E3L-2□4-50	E3L-DS50E4-50
Method of detection		Through-beam type		Diffuse reflective
Supply voltage		12 to 24 VDC, ±10% max. ripple peak-to-peak		
Current consumption		50 mA max.		40 mA max.
Sensing distance		10 m (32.8 ft) with no aperture; 9 m (29.52 ft) with 3 mm aperture; 6 m (19.68 ft) with 2 mm aperture; 3 m (9.84 ft) with 1 mm aperture; 2 m (6.56 ft) with 0.85 mm aperture; 1 m (3.28 ft) with 0.5 mm aperture; 30 cm (11.81 in) with 0.1 mm aperture	2 m (6.56 ft) with 0.85 mm dia. aperture; 20 cm (7.9 in) with 0.1 mm dia. aperture	20 to 50 cm (7.9 to 19.7 in) with 2 x 2 mm (0.09 x 0.09 in) white mat paper
Light source		Visible red, pulse modulated laser diode ($\lambda=670$ nm) 480 μ W max., Class II FDA/IEC	Infrared, pulse modulated laser diode ($\lambda=780$ nm) 25 μ W max., Class I FDA/IEC	
Detectable object type		4 mm (0.16 in) dia. object minimum without aperture; With aperture - object minimum is same as aperture size	0.5 mm (0.02 in) dia. object minimum with 0.85 mm dia. aperture 0.1 mm (0.003 in) dia. object minimum with 0.10 mm dia. aperture	Opaque, translucent objects 2 x 2 mm
Diameter of projected spot		With 4 mm dia. emitter, no aperture, at a distance of 2 m (6.56 ft), the incident light is 20 mm (0.79 in) in diameter		With 4 mm dia. emitter, at a distance of 50 cm (19.7 in) from the emitter, the incident light is 2 mm (0.08 in) in dia.
Directional angle		Emitter: 2° max., Receiver: 20° max.		
Operation mode		Light-ON/Dark-ON, wire selectable Light-ON: + red, - black; Dark-ON: - red, + black		
Sensitivity adjustment		Adjustable		
Mutual interference protection		Standard level		
Control output	DC solid-state	Type	NPN type, open collector	NPN type, constant current source (E3L-□□□□E4-50) PNP type, open collector (E3L-2B4-50)
		Max. load	NPN type: 100 mA max.	NPN type: Load (relay, sink) logic: 80 mA max. Voltage (source) logic: 1.5 to 3 mA PNP type: Load (relay, source) logic: 80 mA max.
		Response time	1 ms max. (both ON and OFF)	
Alarm output	DC solid-state	Type	NPN (E3L-□□□□E4-50); PNP (E3L-2B4-50)	
		Max. load	50 mA, 24 VDC	
		Residual voltage	1 V	
		Response time	Output turns ON after 100 ms delay when light receiving signal level is within unstable zone.	
Circuit protection	Output short-circuit		Provided	
	DC power supply reverse polarity		Provided	
Indicators		Light Incident (red LED), Stable Operation (green LED)		
Materials	Lens		Plastic, PMMA	
	Case		Diecast zinc	

(This table continues on the next page)

Note: In consideration of vibration and other environmental and mounting conditions, the sensing distance values for the E3L-2RC4 are very conservative. If these conditions can be minimized, longer sensing distances are possible. Please see excess gain and operating range curves for more accurate sensing ranges.

Specifications Table - continued from previous page

Part number		E3L-2RC4	E3L-2□4-50	E3L-DS50E4-50
Mounting		Two side mount M4 threaded holes or mounting bracket E39-L6 (supplied)		Two side mount M4 threaded holes or mounting bracket E39-L5 (supplied)
Connections	Prewired	2 m (6.56 ft); 3 conductor cable for emitter, 3 conductor cable for receiver	2 m (6.56 ft); 3 conductor cable for emitter, 4 conductor cable for receiver	2 m (6.56 ft) 4 conductor cable
Weight		Emitter: 160 g (5.6 oz) Receiver: 175 g (6.2 oz)		250 g (8.8 oz)
Enclosure	UL	—		
	NEMA	NEMA 4		
	IEC 144	IP67		
Ambient	Operating	-10°C to 50°C (14°F to 122°F) with no icing		
	Storage	-30°C to 70°C (-22°F to 158°F)		

■ OUTPUT CIRCUIT DIAGRAMS

Sensor	Through-beam	Diffuse reflective
NPN output type	<p>* Alarm (orange) wire not present for E3L-2RC4</p> <p>The indicator can be wired for Light Incident by connecting the black wires together as shown in the dotted line. For Power indication, connect the emitter's black wire to the receiver's blue wire.</p>	
PNP output type	<p>The indicator can be wired for Light Incident by connecting the black wires together as shown in the dotted line. For Power indication, connect the emitter's black wire to the receiver's brown wire.</p>	

■ TIMING CHARTS

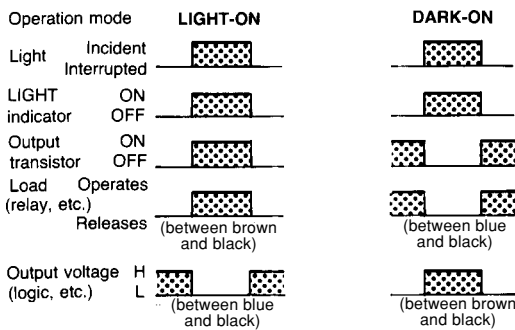

■ EXCESS GAIN

Through-beam Type E3L-2□4-50

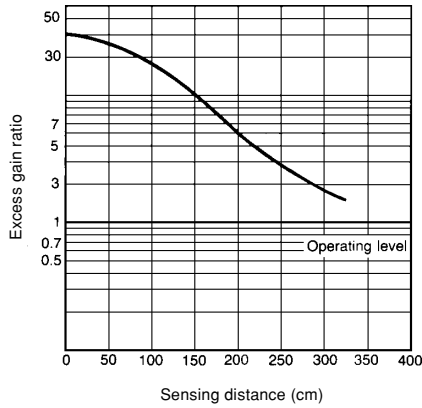

Through-beam Type E3L-2RC4

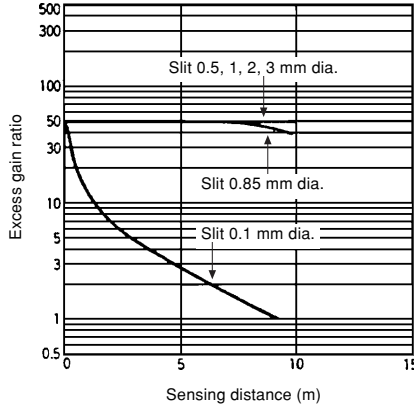

Diffuse Reflective Type E3L-DS50E4-50

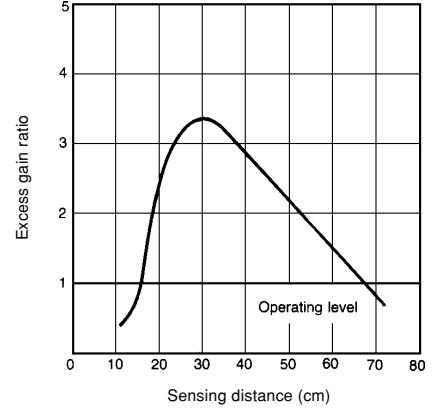

■ OPERATING RANGE

Through-beam Type E3L-2□4-50 without aperture

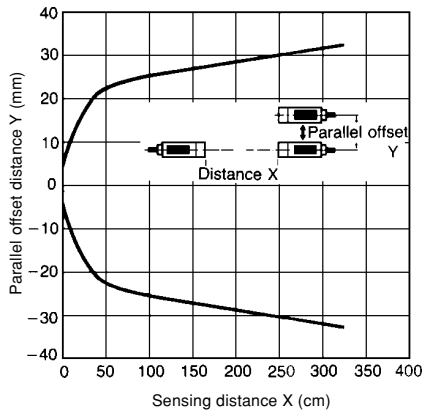

Through-beam Type E3L-2□4-50 with 0.85 mm diameter aperture

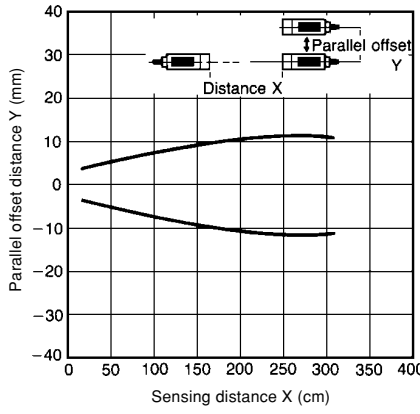

Through-beam Type E3L-2□4-50 with 0.1 mm diameter aperture

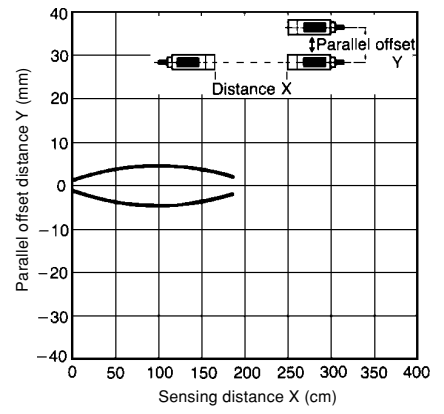

Diffuse Reflective Type E3L-DS50E4-50

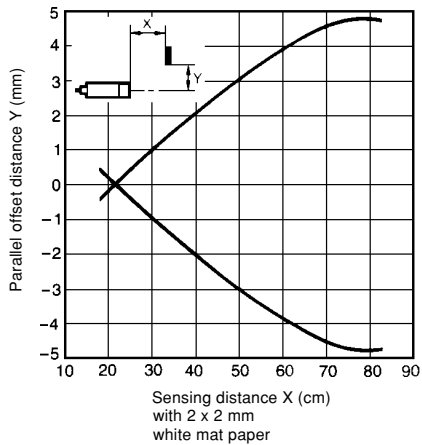

Through-beam Type E3L-2RC4 without aperture

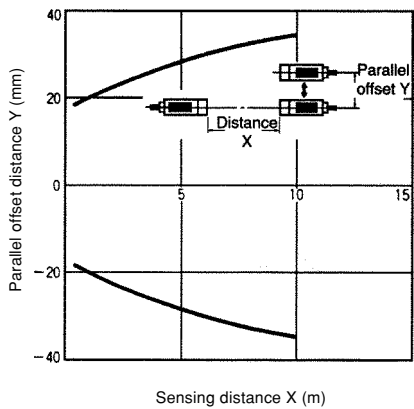

Through-beam Type E3L-2RC4 with 1.0 mm diameter aperture

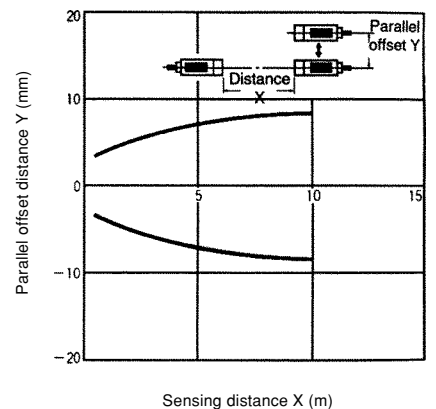

Through-beam Type E3L-2RC4 with 0.85 mm diameter aperture

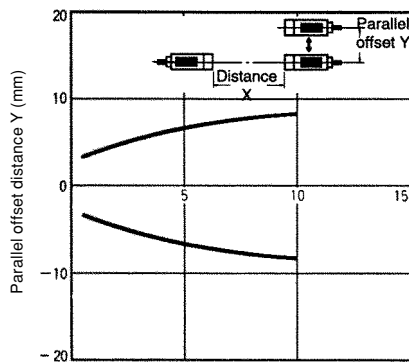

Sensing distance X (m)

Through-beam Type E3L-2RC4 with 0.5 mm diameter aperture

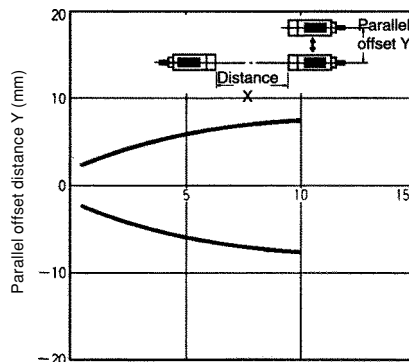

Sensing distance X (m)

Through-beam Type E3L-2RC4 with 0.1 mm diameter aperture

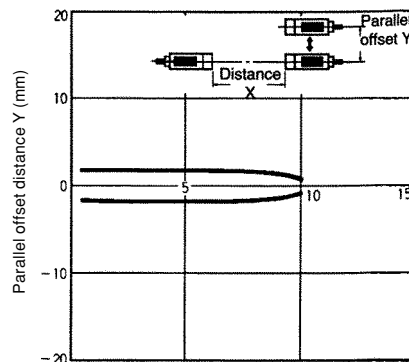

Sensing distance X (m)

Dimensions

Unit: mm (inch)

THROUGH-BEAM TYPE E3L-2□4-□

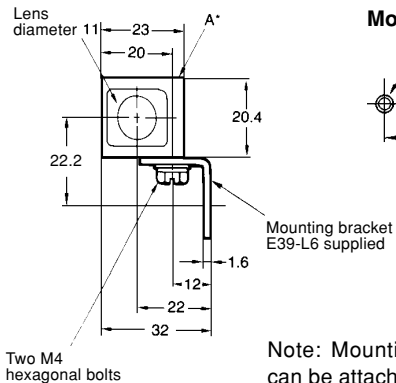
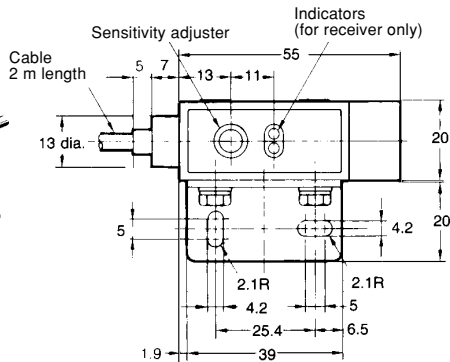
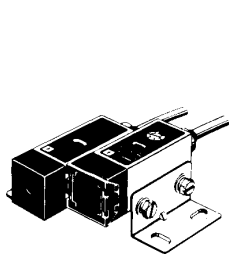

Mounting holes

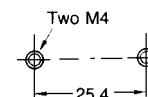

Note: Mounting bracket E39-L6 can be attached to surface "A".

■ **DIFFUSE REFLECTIVE TYPE E3L-DS50E4-50**

Unit: mm (inch)

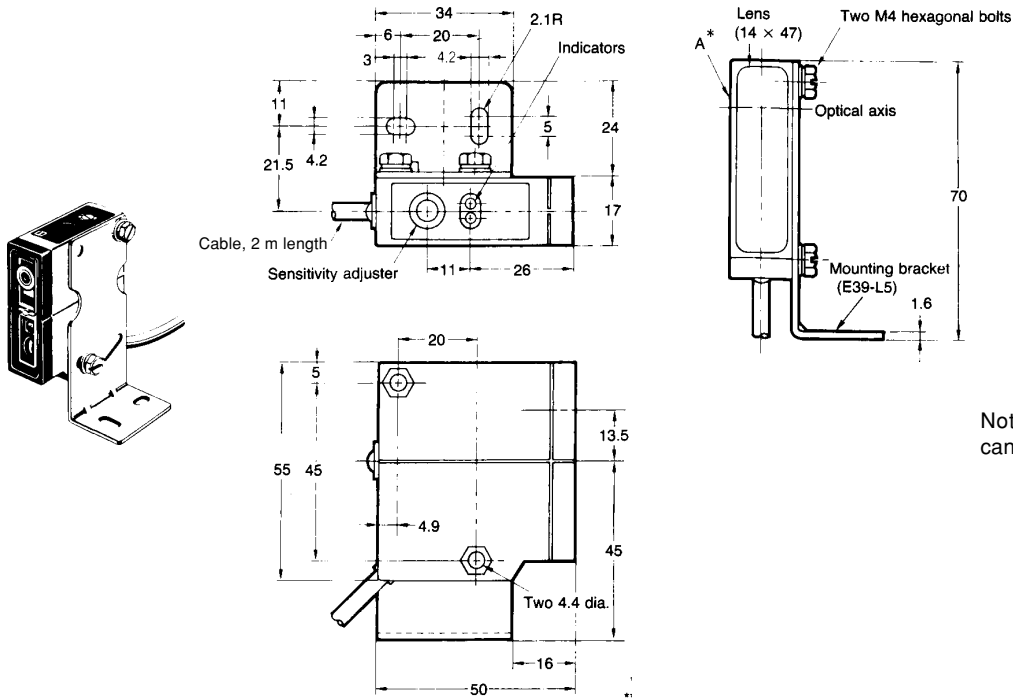

Note: Mounting bracket E39-L6 can be attached to surface "A".

■ **REPLACEMENT PART**

Sensitivity Adjuster Knob E39-G1 (included)

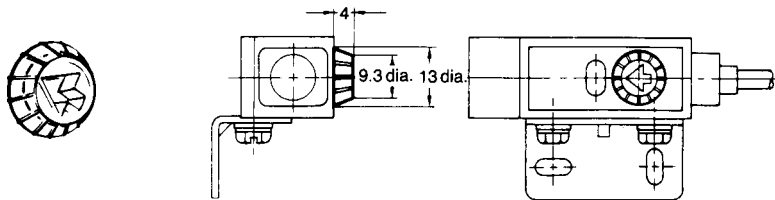

Note: The adjustment knob cannot be removed once it has been installed on the unit.

Operation

■ LIGHT INCIDENT INDICATOR

The LIGHT incident indicator (red LED) illuminates when the light from the emitter is incident on the receiver and exceeds the operating level (trigger point) of the sensor. This indicator illuminates whenever the object is absent for through-beam type and when the object is present for diffuse reflective type.

■ STABILITY INDICATOR

The STABILITY indicator (green LED) illuminates when the control output is in a stable OFF or ON state. A "stable" state occurs when the receiver element of the sensor receives less than 80% (OFF state) or more than 120% (ON state) of incident light needed to operate the sensor.

The control output STABILITY indicator goes off every time the amount of light incident on the receiver is within 20% of the amount of light needed to change the control output state.

The unstable control output condition may occur when the sensor encounters the leading and trailing edges of the object to be detected. However, the alarm output described later will not operate if the unstable condition recovers within 100 ms. The condition can occur when a change in sensor position, atmosphere (dust contamination), temperature or ambient light causes the light incident on the receiving element to be near the operating level of the sensor.

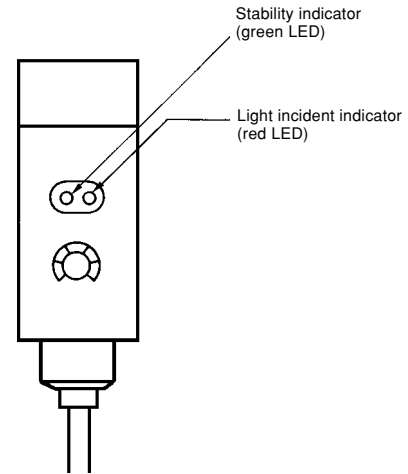

■ ALARM OUTPUT (-50 models)

The alarm output operates when the control output is in an unstable OFF or ON state for more than 100 ms. An unstable state occurs when the amount of light incident upon the receiver is within 20% of the amount of light needed to change the control output state.

The alarm output feature indicates gradual degradation of stability caused by changes in sensor position, atmosphere, temperature or ambient light that will eventually result in an unstable control output. A change that occurs in less than 100 ms will not cause the alarm output to operate.

A 100 ms time delay is built into the alarm output circuit. This prevents false triggering of the alarm output as the leading and trailing edges of the object to be detected are sensed. When sensing objects moving at low speeds, a separate ON-delay timer should be used to prevent false triggering of the alarm output.

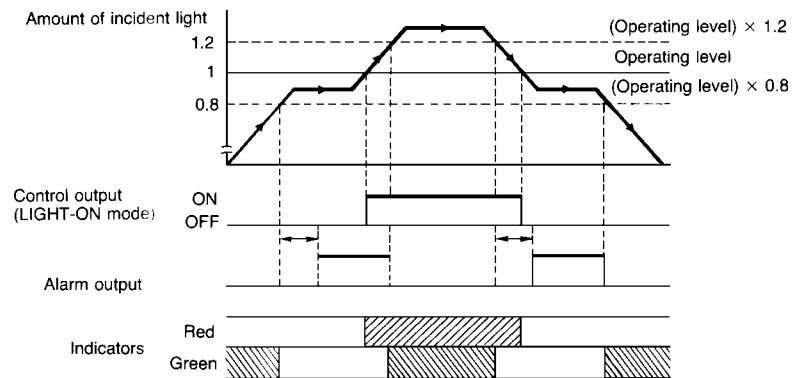

Precautions

■ STATIC ELECTRICITY

When handling the device, special care should be taken to avoid static electricity, as any static discharge can damage the laser diode element of E3L photoelectric sensor.

■ LASER REGULATIONS

The E3L laser photoelectric sensor is intended for use as an element incorporated into a larger system.

The E3L laser photoelectric sensor meets the standards required by the Food and Drug Administration (FDA) in the United States. OMRON has had also reported to the Center for Devices and Radiological Health (CDRH). The report includes the condition that the unit is to be used as a part of a larger system.

Labels (FDA Regulations)

For products sold in North America, attach the following FDA safety labels for the appropriate sensor body prior to use. Some or all of these labels may already be attached.

Caution Label

E3I-2RC4



Certification and Identification Label

E3L-2L□4-50

TYPE E3L-2L□E4-50
(Tc=25°C, 25 μW)
T: 50 μsec ts: 2.5 μsec f: 20 kHz
This product complies with 21 CFR 1040.10 and 1040.11
OMRON Corporation
10 TSUCHIDO-CHO, HANAZONO, UKYO-KU, KYOTO 615 JAPAN
MANUFACTURED JAN, 1990

E3L-DS50E4-50

TYPE E3L-DS50E4-50
(Tc=25°C, 25 μW)
T: 200 μsec ts: 5 μsec f: 5 kHz
This product complies with 21 CFR 1040.10 and 1040.11
OMRON Corporation
10 TSUCHIDO-CHO, HANAZONO, UKYO-KU, KYOTO 615 JAPAN
MANUFACTURED JAN, 1990

E3L-2LRC4

TYPE E3L-2LRC4
(Tc=25°C, 40 μW)
T: 60 μsec ts: 5 μsec f: 16.7 kHz
This product complies with 21 CFR 1040.10 and 1040.11
OMRON Corporation
KARASUMA NANAJO, SHIMOGYO-KU, KYOTO 600 JAPAN
MANUFACTURED , 1990

Aperture Label for E3L-2LRC4

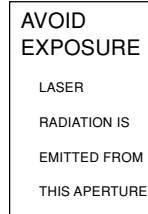

Labels (European)

For exports to European countries, attach the appropriate label shown below to the cable.

E3L-2□4-50 & E3L-DS50E4-50



E3L-2RC4

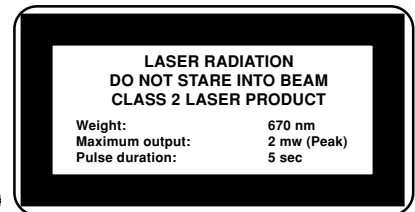

■ MAINTENANCE

The E3L laser photoelectric sensor contains no user-serviceable parts. Refer all servicing to an authorized OMRON agent.

These devices generate Class I or Class II laser radiation. Avoid looking at the beam for prolonged periods.

Caution

Do not disassemble the unit. Users expose themselves to the risk of laser radiation if they disassemble the device, or use it for any purpose other than those described in this data sheet or in the instruction sheet provided with the unit.

Note: For more information on laser safety and requirements, please see Omron's Measurement Sensors Catalog.

OMRON

OMRON ELECTRONICS LLC

One East Commerce Drive
Schaumburg, IL 60173

1-800-55-OMRON

OMRON ON-LINE

Global - <http://www.omron.com>
USA - <http://www.omron.com/oei>
Canada - <http://www.omron.com/oci>

OMRON CANADA, INC.

885 Milner Avenue
Scarborough, Ontario M1B 5V8

416-286-6465